

Prototyping Fragile Buffer Packaging: From Existing to Potential

ARIYATHILAKE P.B.S.D^{1*}, and SAMARAWICKRAMA. S²

^{1,2}Department of Integrated Design, Faculty of Architecture, University of Moratuwa, Sri Lanka.

¹deshaniariyathilake@gmail.com, ²sumanthris@uom.lk

Abstract – *The fragility of a product reflects its mechanical properties, particularly its ability to resist dynamic shock when subjected to impact or vibration. When the force exerted on the product exceeds its tolerance, the structure becomes compromised, leading to damage or failure. To prevent such occurrences, fragile buffer packaging plays a crucial role in packaging design. Its primary function is to absorb shocks and vibrations during handling and transport, thereby protecting delicate items from damage. This paper focuses on fragile buffer packaging through a single-case study—a waffle-based fragile product used as edible cutlery. It examines the existing packaging design that contributes to product damage and emphasizes the importance of applying fragile buffer packaging principles to develop a more effective final packaging through a step-by-step process of developing prototypes. Applying fragile buffer packaging requirements confirms that the proposed packaging design is a superior alternative to the existing one, with the potential for significantly enhanced product protection.*

Keywords: *Fragile food packaging, fragile puffer packaging, prototyping, packaging design process*

*Contact: phone +94-771897206

DOI: [https://doi.org/10.31705/IDR.v1\(1\).2024.8](https://doi.org/10.31705/IDR.v1(1).2024.8)

Copyright © 2024, Integrated Design Research, Department of Integrated Design, University of Moratuwa, Sri Lanka

I. Introduction

This paper begins with a discussion on the importance of buffer packaging, emphasizing its critical role in protecting fragile items during handling and transportation. The selected single-case study—a waffle-based fragile product—underscored the necessity of buffer packaging and reaffirmed the research aim of this article. This aim was achieved by integrating insights from relevant literature on buffer packaging and applying them throughout the prototyping process.

The article documents the step-by-step design decisions taken during the prototyping stage to arrive at an alternative packaging solution, focusing on how the principles of buffer packaging were applied. This phase emphasized stability, convenience, ecological considerations, and cost efficiency. The work captures the iterative development of the packaging solution, reflecting on various design strategies and choices that addressed these key factors. Additionally, the article explores different design methods, such as examining geometric shapes and assembly techniques, to optimize the packaging's performance.

This comprehensive documentation aims to provide a clear understanding of the development process and the rationale behind each decision made to create an effective, balanced buffer packaging solution.

II. Fragile buffer packaging within the packaging Design

Fragile buffer packaging plays a critical role in the broader domain of packaging design, aimed specifically at protecting delicate and breakable items during transportation and storage (Gao et al., 2021). Its primary function is to absorb shocks, vibrations, and external forces, ensuring that fragile items like electronics, glassware, and medical instruments reach their destination intact. According to Lee (2024), fragile items are particularly vulnerable to damage during transit, and specialized packaging is required to minimize this risk. This type of packaging integrates various materials and structural elements that work together to create a secure and cushioned environment for fragile products.

One of the key elements of fragile buffer packaging is the use of cushioning materials designed to absorb external impact and prevent movement inside the packaging (Yang et al., 2023). Bubble wrap, for instance, is a widely used cushioning material due to its low cost and effectiveness in protecting items through air-filled bubbles that dissipate force upon impact (Chopra et al., 2022). Foam inserts are custom-molded to fit the shape of the product providing a snug fit that immobilizes the item (Borras, 2022), while molded pulp serves similar protection with limited shapes, but works as an environmentally friendly option that combines strength with the ability to absorb impact (Debnath et al., 2022). Air pillows, another option, are inflatable plastic cushions that fill empty spaces in the package. They act as a barrier around the item, preventing it from shifting during transit and absorbing impact (Carla, 2021). In contrast, paper padding—often in the form of crumpled or molded paper—offers an eco-friendly alternative to plastic-based materials (Dutt et al., 2003).

The structural support provided by the outer packaging is equally important in protecting fragile items. Corrugated cardboard boxes are frequently used as outer packaging due to their strength and multi-layered composition, which provides a rigid shell to resist external pressure (Gok, & Akpınar, 2020). Suspension packaging, which suspends the product within the packaging using plastic films or other materials, offers an innovative solution for

*Contact: phone +94-771897206

DOI: [https://doi.org/10.31705/IDR.v1\(1\).2024.8](https://doi.org/10.31705/IDR.v1(1).2024.8)

Copyright © 2024, Integrated Design Research, Department of Integrated Design, University of Moratuwa, Sri Lanka

high-value items by keeping them away from the box walls, thus minimizing the risk of damage from external pressure (Nica et al., 2021).

Fragile buffer packaging is widely used across industries that handle delicate and high-value products, such as the electronics, glassware, art, and fragile food industries (Kun & Xi, 2017; Gao et al., 2021). Across these industries, the use of fragile buffer packaging has become indispensable in maintaining the quality and integrity of products during transportation and handling, ensuring that the product remains intact during transit. Although the cost of high-quality packaging materials is often higher, it is justified by the reduced risk of damage, particularly for high-value items (Pei et al., 2023). Therefore, designing such packaging requires careful consideration to absorb shocks and vibrations while securing products during transit.

III. Background of the Selected Product and Current Packaging

Edible cutlery, a waffle-based fragile product produced by a local small and medium enterprise (SME), has been identified by the Sri Lankan Export Development Board (EDB) as a potential export product due to its viability as an alternative to single-use plastic cutlery. Currently, the SME uses packaging in which five bowls and five spoons (Figure 1) are stacked vertically in a sealed polyethylene cover, serving as the primary packaging. The secondary packaging consists of a 120gsm gray-back cardboard box that encloses three of these primary packs (Figure 2), with each package containing a total of 15 fragile bowls and spoons. This existing packaging protects the product from moisture and helps maintain its crisp texture.

However, closer observation of the product characteristics and current packaging—through both observational analysis and interviews with the SME—revealed that goods often arrive damaged in the customer’s hands. As a result, customers frequently return damaged products, leading to increased transportation costs and the need for replacements. This damage not only results in revenue loss but also negatively affects the company’s reputation, reducing customer satisfaction and leading to lost sales and future business opportunities. Additionally, the SME reported that product damage leads to wasted materials and resources during manufacturing and distribution, emphasizing the need for a more effective packaging design solution.

This paper presents the design process of developing prototypes to create a final packaging design solution, with a focus on structural development for fragile buffer packaging.

Figure 1
View of the edible bowl and edible spoon

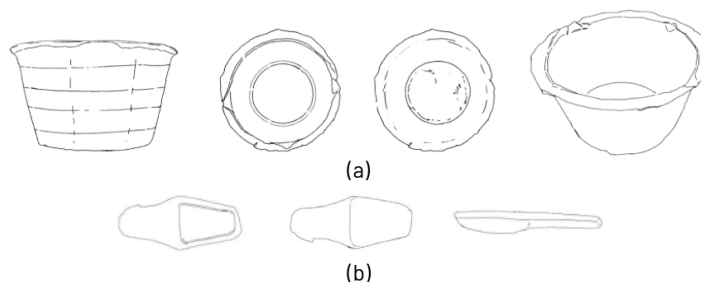

Note. (a) 3D view of the edible bowl, (b) 3D view of the edible spoon

*Contact: phone +94-771897206

DOI: [https://doi.org/10.31705/IDR.v1\(1\).2024.8](https://doi.org/10.31705/IDR.v1(1).2024.8)

Copyright © 2024, Integrated Design Research, Department of Integrated Design, University of Moratuwa, Sri Lanka

Figure 2

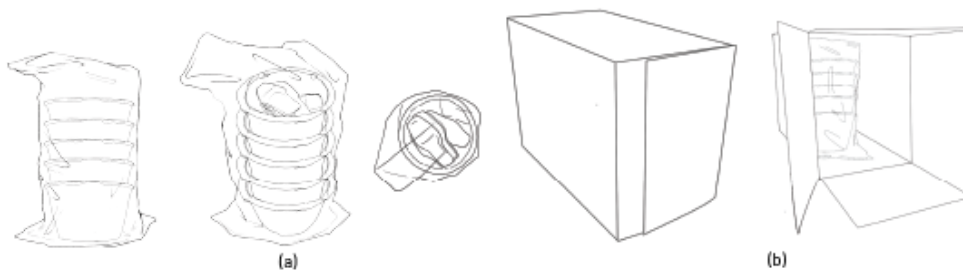

Note. (a) 3D view of the existing primary package, (b) 3D view of the existing secondary package

IV. Current Packaging Structure in Response to Fragile Buffer Packaging

The fragility of the product reflects its mechanical properties, particularly its ability to resist dynamic shock when subjected to impact or vibration. When the impact force exceeds the product's tolerance, its structure becomes compromised, leading to damage or failure. The selected fragile product is particularly susceptible to damage at multiple stages of handling. This begins with the filling of the product into the primary polyethylene package, where excessive pressure or mishandling can lead to cracks or breakage. During the sealing and handling of the secondary packaging, improper sealing techniques or rough handling can result in weakened structural integrity. Additionally, stacking and storage pose significant risks, as uneven pressure or excessive weight can cause crushing or deformation. The transportation of tertiary packaging is another critical point, where vibrations and jolts during transit can lead to microfractures or complete product failure. Finally, even when displayed on store shelves, the product remains vulnerable to accidental drops, shifting during restocking, and improper handling by customers.

The following is a detailed observation of the current packaging of the selected single case, highlighting the issues that must be addressed when developing a new packaging design solution that incorporates effective buffer packaging. This analysis will cover areas such as the adequacy of cushioning materials, the strength and durability of the current packaging structure, and the overall design's ability to absorb impact and minimize vibration to protect the product throughout its entire journey from packaging to consumer use. This is discussed under four key points.

A. Stability

Stability is the top priority in designing fragile buffer packaging. Its main purpose is to securely fix and cushion fragile items, reducing the risk of breakage during transportation. A safe, stable packaging structure is essential to prevent damage and ensure protection (Gao et al., 2021). The current packaging falls short in this aspect; the primary packaging lacks effective fixation and cushioning, allowing the edible cutlery to shift within the secondary package. This excessive space permits movement, which significantly increases the risk of damage, as shown in detail indicated in sections a, b, and c of Figure 3.

*Contact: phone +94-771897206

DOI: [https://doi.org/10.31705/IDR.v1\(1\).2024.8](https://doi.org/10.31705/IDR.v1(1).2024.8)

Copyright © 2024, Integrated Design Research, Department of Integrated Design, University of Moratuwa, Sri Lanka

Figure 3

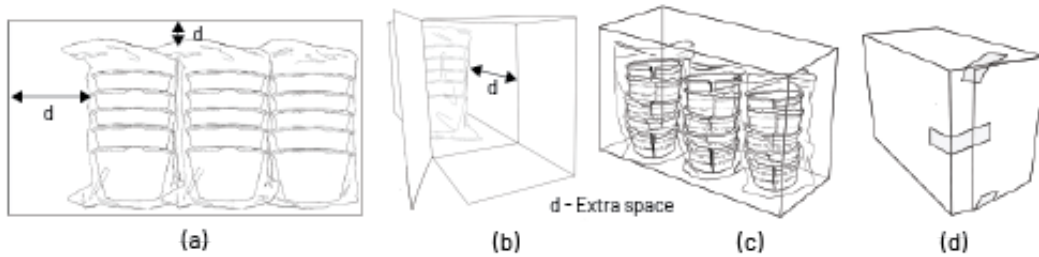

Note. (a), (b), (c), The secondary packaging lacks fixation and cushioning. (d), Absence of convenience in response to portion size and opening and closing.

B. Convenience

Convenience involves ease of assembly, packing, handling, opening, and closing. Regarding convenience, the current primary packaging does not effectively address portion control or resealability, which becomes problematic when the product is not consumed entirely in one use. Additionally, while the product is stacked to fit the height of the secondary packaging, this design overlooks practical considerations for resealing or partial use. The secondary packaging itself is sealed with tape, which may not facilitate easy opening or closing for repeated access, as indicated in (d) of Figure 3.

C. Ecology

Ecological principles emphasize the use of environmentally friendly materials and the reduction of waste (Muthu, 2020; Boylston, n.d.). While the current secondary packaging, made from paper, aligns with sustainable practices, the use of polyethylene poses a challenge as it is non-biodegradable and does not fully adhere to ecological principles. Additionally, sustainability in food packaging extends beyond materials to include the prevention of food waste (Klein et al., 2024). The current packaging incorporates polyethylene-coated boards as a moisture barrier to protect the product's perishable nature, balancing the ecological need for preservation with material concerns. By reducing non-biodegradable materials in secondary packaging, the design aligns with positive environmental impact goals, supporting the product's positioning as an alternative to conventional plastic cutlery.

D. Cost-Effectiveness

Balancing protective features with cost considerations is vital (Klimchuk & Krasovec, 2018; Morris, 2015). The current packaging design, with its additional space and need for cushioning materials, may lead to increased production costs. However, when weighed against potential costs related to product damage and potential drops in sales due to compromised product quality, these expenses may be justified. Addressing cost-effective solutions that maintain protection while optimizing material usage is essential.

In designing the prototypes as an alternative to the current packaging, these factors were carefully considered alongside user studies, product characteristics, required barrier properties, and supply chain analysis. This approach was applied to ensure a balanced, effective packaging solution. The progressive development of the prototypes is documented in the next section as a contribution to the research and as the primary aim of this article.

*Contact: phone +94-771897206

DOI: [https://doi.org/10.31705/IDR.v\(1\).2024.8](https://doi.org/10.31705/IDR.v(1).2024.8)

Copyright © 2024, Integrated Design Research, Department of Integrated Design, University of Moratuwa, Sri Lanka

V. The Development and the Prototyping Process

The prototyping stage was structured into two main stages, with this article emphasizing the second stage, which focuses on the prototyping of the product's packaging, particularly the secondary packaging.

Stage 01: Morphological Design and Prototyping Approach

This stage focused on analyzing the physical form and structure of the product, breaking down complex systems into fundamental components, and examining their interactions to identify potential improvements. The initial step involved a detailed study of the existing shape of the product in developing a molded substitute (Figure 4). To achieve this, the first prototype was created using a pulp-based product model. Through the application of morphological prototyping, a simplified geometric shape that closely resembled the product's structure was identified. This shape served as the foundation for prototype development and as an inspiration for molded pulp design. The molded pulp prototype was also used to test the shape's effectiveness in immobilizing the product, ensuring it remained secure during handling and transportation as an alternative to the product itself. The next phase involved the development of an insert that contributed to the product's stability and protection within the packaging.

Figure 4

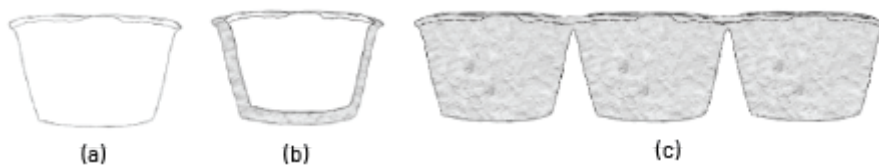

Note. Pulp-based product prototype- (a), The existing shape of the edible cutlery. (b), The edible cutlery inside the molded fiber packaging. (c), Molded product as a set as an alternative to the product itself

Stage 02: Prototyping and Application of SWOT Analysis for Secondary Packaging

This stage focused specifically on the development and evaluation of the secondary packaging prototypes to achieve a buffer packaging design solution. The prototypes were designed not as product prototypes but as packaging solutions intended to protect and cushion the product effectively. SWOT (Strengths, Weaknesses, Opportunities, and Threats) analysis was applied to each prototype to assess its effectiveness in providing product protection and serving as a buffer packaging solution. This analysis facilitated iterative development by identifying areas for refinement and guiding strategic decision-making, ensuring a comprehensive evaluation of each prototype's current state and potential enhancements. The analysis took into account user studies, product characteristics, required barrier properties, and supply chain requirements to optimize the design. This documentation forms the basis of the next section, presenting the evaluation process and the iterative development of prototypes as an alternative to the current packaging.

*Contact: phone +94-771897206

DOI: [https://doi.org/10.31705/IDR.v1\(1\).2024.8](https://doi.org/10.31705/IDR.v1(1).2024.8)

Copyright © 2024, Integrated Design Research, Department of Integrated Design, University of Moratuwa, Sri Lanka

VI. Discussion

The development and evaluation of the secondary packaging prototype began with an understanding of the importance of stability followed by convenience, Ecological aspects, and Cost-effectiveness. It is essential to design fragile buffer packaging to securely fix and cushion items, reducing the risk of breakage during transportation. The development and evaluation of the secondary packaging prototype focused on minimizing movement to prevent contact that could damage the product. An insert was identified as an effective solution for enhancing stability, as it compartmentalizes items to prevent contact, reduces the need for additional protective materials, and streamlines assembly while saving labor (Muhammad, 2024). Ho (2020) notes that a trap insert ensures the component remains in a stable and aesthetically pleasing position while securely holding it and providing protection against impacts.

- A. The initial insert design, shown in Figure 5 (a), made direct contact with the outer packaging, which limited its buffering effectiveness. In contrast, design (b) included a gap between the product and the outer packaging, preventing direct force from causing breakage and enhancing overall stability. The dieline of the insert, depicted in Figure 05 (c), demonstrated how the structure supported the product by maintaining a protective space. This insert successfully reduced breakage from external contact and internal movement, serving as an effective buffer solution.

However, while the insert design showed strengths in stabilizing the product, it also revealed weaknesses, particularly in space utilization. These insights pointed to opportunities for refining the design and exploring alternative solutions in the next stage of prototype development.

Figure 5

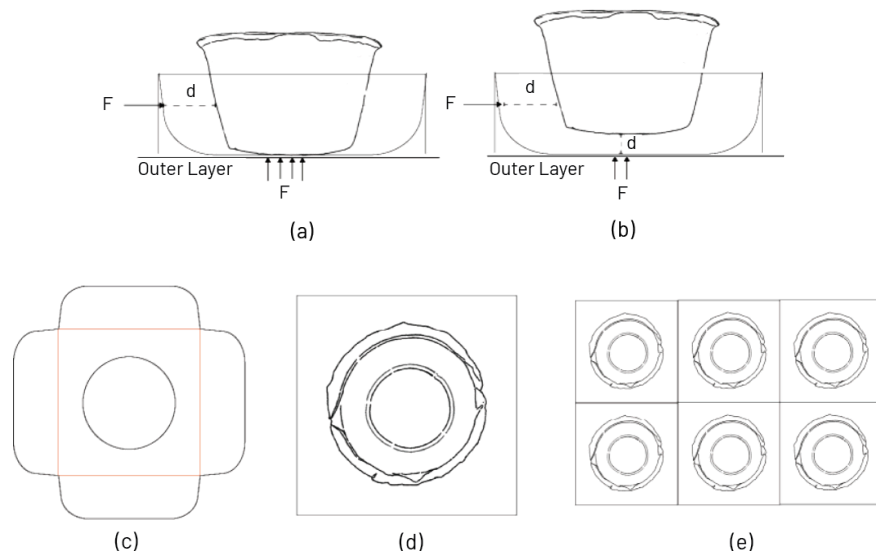

Note. Stability: Application of an Insert for Buffering – (a), Insert without distance from the outer layer. (b), Insert with distance from the outer layer. (c), Insert dieline. (d), Top-down view of the insert with the product placed inside. (e), Top-down view of multiple stacked inserts with a product placed inside

*Contact: phone +94-771897206

DOI: [https://doi.org/10.31705/IDR.v\(1\).2024.8](https://doi.org/10.31705/IDR.v(1).2024.8)

Copyright © 2024, Integrated Design Research, Department of Integrated Design, University of Moratuwa, Sri Lanka

Figure 6

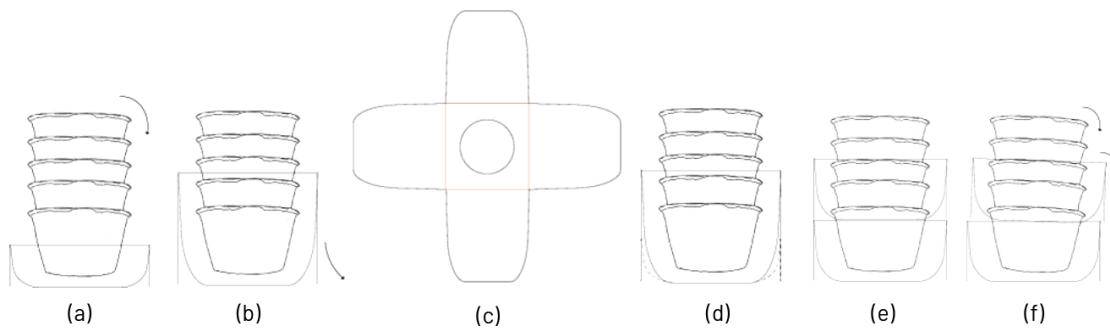

Note. Stability: Application of Stacking and Effective Space Utilization - (a) Arrangement of five products in the insert with a distance from the outer layer. (b), Arrangement of five products within the modified insert. (c), Modified insert dieline. (d), Arrangement of five products within two inserts. (e), Insert layering. (f), Unstable insert layers

- B. Effective space utilization can be enhanced through the stacking of products. Based on user studies and portion sizes for the targeted users, stacks of five products were created to contribute to convenience. However, maintaining stability with stacks of five products presented challenges. The initial insert design, shown in Figure 6 (a), required improvements due to the combined height and width of the stacked items. To address this, a modified insert (b) (c) was developed, but it lacked sufficient strength to support the load due to the limitations of the paper's strength and length.

Thereafter, to enhance stability, two inserts were combined, as depicted in Figure 6 (d), (e). While this approach offered greater stability compared to design (a), it led to material inefficiency and waste. The arrangement of five products within the two combined inserts, shown in (e), highlighted the improved setup, yet it remained somewhat unstable, as indicated by Figure 6 (f). This stage emphasized the importance of designing inserts that balance stability with efficient material use.

These findings underscored the need for further refinement and highlighted both strengths and weaknesses in the design. The application of inserts demonstrated clear strengths in improving product fixation, contributing to greater stability. However, the weaknesses in the stacking method and space utilization posed significant challenges, revealing threats related to material inefficiency and potential instability under load. This stage emphasized opportunities for strategic improvements, such as enhancing insert strength and optimizing material use, to develop a stable, space-efficient packaging solution.

- C. Different stacking methods were explored to utilize space more effectively, as demonstrated in Figure 7. Three sets of primary packaging were stacked in various configurations and shapes. Common geometric shapes such as circles, triangles, hexagons, and squares were analyzed to optimize the arrangement of three primary packages and the compartmentalization of the tertiary package. These configurations were tested using both linear and nonlinear stacking methods. The experiments identified the nonlinear stacking method, shown in the third column of Figure 7, as the most efficient for space utilization. Among the shapes tested, the triangular

*Contact: phone +94-771897206







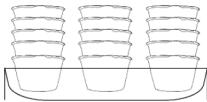
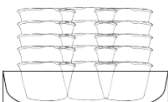
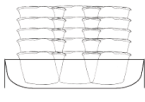
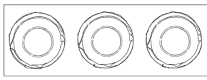

DOI: [https://doi.org/10.31705/IDR.v1\(1\).2024.8](https://doi.org/10.31705/IDR.v1(1).2024.8)

Copyright © 2024, Integrated Design Research, Department of Integrated Design, University of Moratuwa, Sri Lanka

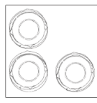
arrangement was found to be the most effective, as other shapes required more material and did not maximize space as efficiently. Following further refinements and prototype development, the final shape of the secondary packages, shown in the last row, third column of Figure 7, was established.

This stage simultaneously involved an examination of the insert (Figures 5 and 6) to achieve optimal use of space and material for the prototyping of secondary packaging shapes. The comparison between linear and nonlinear stacking methods revealed that, while linear stacking required additional partitioning, nonlinear stacking needed only a single main partition, confirming the decision on the final shape (Figure 8, 3rd column). Additionally, it was observed that inserts stacked directly on top of one another were unstable. Therefore, the insert needed to function as a tray to securely stack the fragile products. An insert was thus designed to minimize the impact of both upward and downward forces from the outer packaging (Figure 9). This insert was constructed as a single unit with two components: one part focused on stabilizing the three primary packages (Figure 10b), while the second part was designed in a tiered (stair-like) structure to support the first part, functioning as a tray, as shown in Figures 10a and 11. The development of the dieline further facilitated the analysis of material use and helped identify areas for optimization (Figures 11b, 11c, and 11d). These dielines detail the structured design of the inserts, showcasing the layout for each system component.

Figure 7

	Linear Stacking	Non-Linear Stacking	
Side View of Stacking			
Top-down view of Stacking			
Different Shapes analysis for space optimization			
Optimal Shape for Space Utilization			

Note. Exploration of Stacking Methods to Utilize Space Effectively

Additionally, the insert's design allows it to be used as a serving tray, enhancing user convenience while maintaining product stability, as depicted in Figure 11.

*Contact: phone +94-771897206

DOI: [https://doi.org/10.31705/IDR.v1\(1\).2024.8](https://doi.org/10.31705/IDR.v1(1).2024.8)

Copyright © 2024, Integrated Design Research, Department of Integrated Design, University of Moratuwa, Sri Lanka

Figure 8

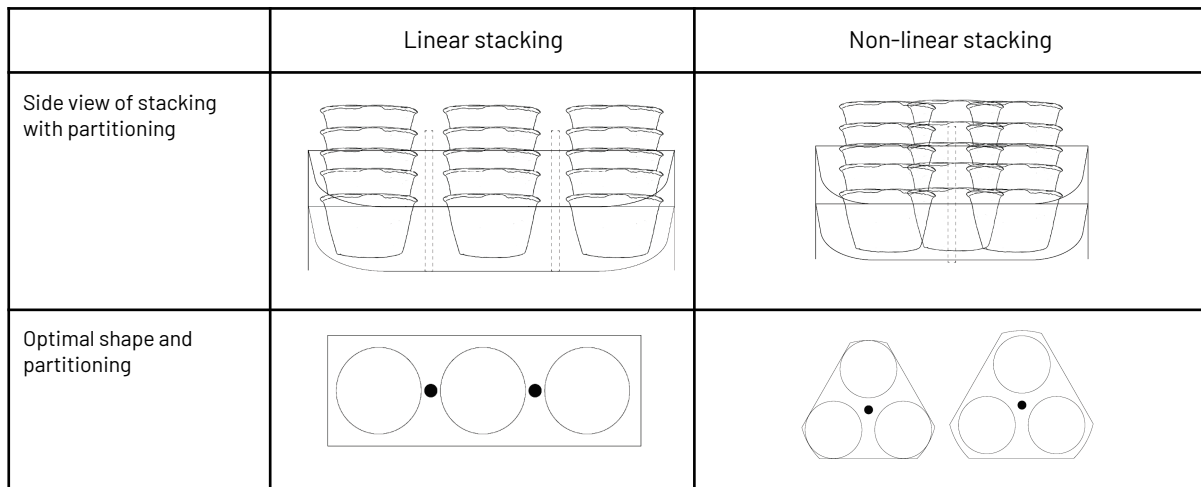

Note. Exploration of Inserts for Effective Space and Material Utilization

Figure 9

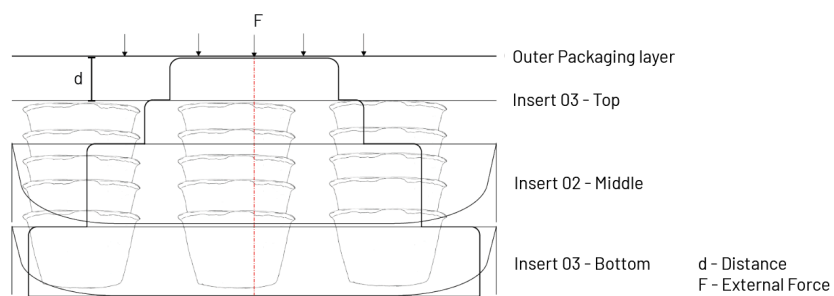

Note. Cross-Sectional View of the Insert System, Illustrates how the insert system is structured to secure and stabilize the primary packages while minimizing the impact of external forces.

Figure 10

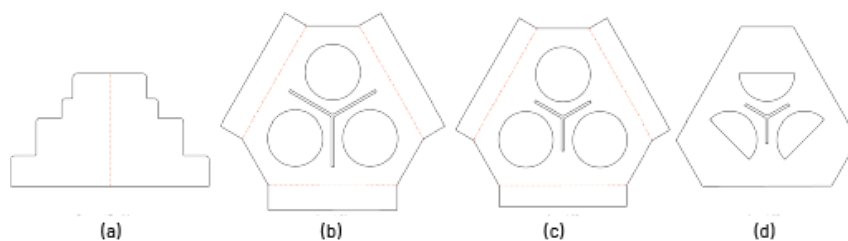

Note. Insert System dielines - (a), dieline of the support partition. (b), dieline of Insert O1 (bottom layer). (c), dieline of Insert O2 (middle layer). (d), dieline of Insert O3 (top layer).

Figure 11



*Contact: phone +94-771897206

DOI: [https://doi.org/10.31705/IDR.v\(1\).2024.8](https://doi.org/10.31705/IDR.v(1).2024.8)

Copyright © 2024, Integrated Design Research, Department of Integrated Design, University of Moratuwa, Sri Lanka

Note. Insert Used as a Serving Tray for Users: Depicts the insert functioning as a tray, enhancing user convenience while maintaining product stability.

- D. With the packaging shape finalized and buffer packaging addressed, this stage focused on analyzing the convenience and cost considerations of the prototype through the lens of SWOT analysis. To enhance convenience—a key strength—the initial secondary packaging dieline, which featured a lock-only system without pasting, was revised. Various geometric shapes were explored to inspire and refine the final design. The updated design reduced the number of locks and incorporated minimal pasting using paperboard material, creating an opportunity for simpler assembly and faster production. This adjustment highlighted the strength of the practical assembly, transitioning the packaging from a flat state to its final form, but it also revealed a weakness in the form of increased material usage and assembly time.

A critical factor in this evaluation was the time spent on assembly and testing both locking and pasting methods. Although both designs required manual assembly, the pasting method proved to be a strength, as it was faster and required less precision, which lowered standard minute values (SMV) and improved overall production speed. However, a potential threat was identified in the form of labor costs and the long-term efficiency of assembly methods. While locking systems had the advantage of flat packing and easy delivery, the pasting method presented an opportunity for greater convenience during assembly and positively impacted labor costs, making it a viable option for streamlined production.

Figure 12

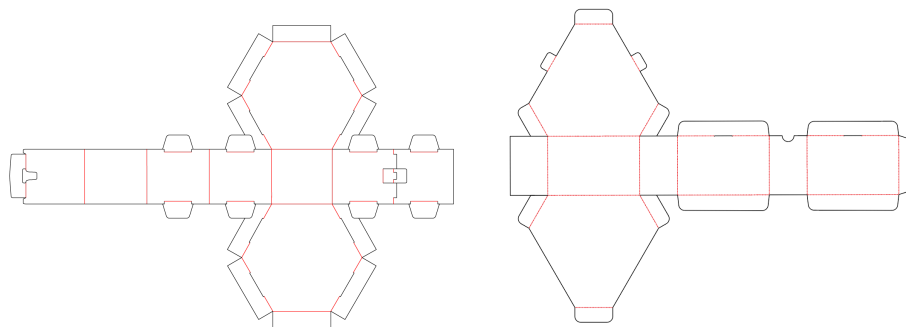

Note. Comparative Designs for Secondary Packaging - (a), Lock-only design. (b), Lock-and-paste design

By considering factors such as cost, material efficiency, labor, and the final product's quality, the final prototype design capitalized on the strengths of convenience and efficiency. The decision to adopt option (a), which featured minimal pasting, demonstrated a strategic approach to balancing weaknesses and threats with opportunities for improved assembly and production efficiency.

*Contact: phone +94-771897206

DOI: [https://doi.org/10.31705/IDR.v1\(1\).2024.8](https://doi.org/10.31705/IDR.v1(1).2024.8)

Copyright © 2024, Integrated Design Research, Department of Integrated Design, University of Moratuwa, Sri Lanka

Figure 13

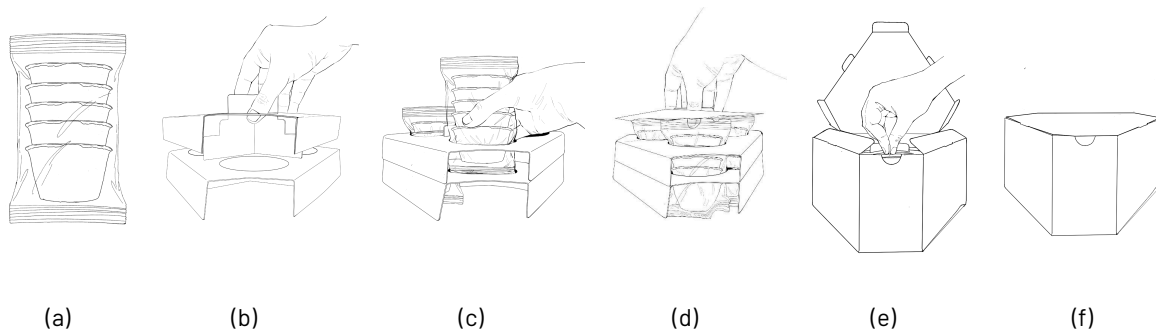

Note. Steps in the filling process respectively

Figure 14



Note. Developed Prototypes - Completed as a Submission for the Undergraduate Packaging Design Project

Overall, the proposed alternative packaging for the fragile item (Figure 13), when compared to the existing packaging (Figures 2 and 3), effectively addressed the importance of buffer packaging to secure the product. The primary packaging consists of a flexible pouch (Figure 13a) that can be filled and sealed in a single automated operation. The insert was designed to allow the primary packages to slide into place smoothly without friction, significantly reducing the risk of breakage (Figure 13c)—an important improvement over the current packaging. The grip-friendly structure of the insert facilitates easy handling, enabling quick and seamless placement (Figure 13e) into the preformed secondary packaging, which features a wide-mouth opening for efficient filling (Figure 13e). The secondary packaging can be sealed swiftly, completing a streamlined process for opening and closing, while also providing the option to use portions or store the product for later use (Figure 13f).

An area for improvement is the consideration of stacking the secondary packages into tertiary corrugated boxes. Figure 15 illustrates a few methods of stacking; however, these methods indicate a high potential for space wastage. A comparative cost analysis could be conducted to assess the trade-off between potential damage costs and material waste. Due to time constraints and the nature of this being part of an undergraduate Packaging Design project, further refinements are necessary to fully optimize the design. Additionally, these packaging prototypes could benefit from further testing, such as compression, impact, drop, cushioning performance, and edge crush tests, to evaluate and enhance their performance under real-world conditions.

*Contact: phone +94-771897206

DOI: [https://doi.org/10.31705/IDR.v1\(1\).2024.8](https://doi.org/10.31705/IDR.v1(1).2024.8)

Copyright © 2024, Integrated Design Research, Department of Integrated Design, University of Moratuwa, Sri Lanka

Figure 15

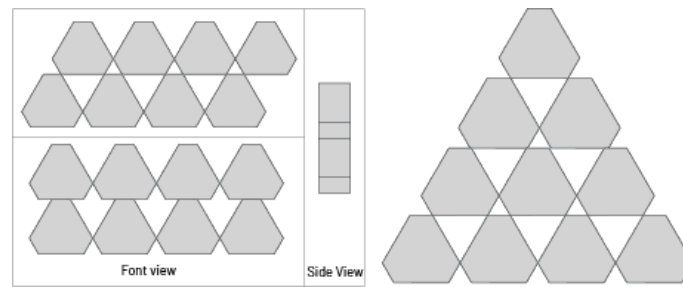

Note. Potential Stacking Methods for Tertiary Packaging and Product Display

Conclusion

This study underscored the essential role of buffer packaging in protecting fragile items during handling and transport, focusing on a single-case study involving a waffle-based edible cutlery product. The proposed alternative packaging design (Figure 13), compared to the existing packaging (Figures 2 and 3), demonstrated significant improvements, addressing stability, convenience, ecological impact, and cost efficiency.

The primary packaging, a flexible pouch (Figure 13a), facilitated efficient, automated filling and sealing. The redesigned insert allowed the primary packages to slide smoothly into place without friction (Figure 13c), reducing breakage risk—a notable advancement over the existing design. The insert's grip-friendly structure (Figure 13e) further enhanced handling and served as a tray for post-use convenience. Lightweight yet durable paperboard was used for the buffer and outer packaging, ensuring the overall packaging remained strong enough for transit while reducing shipping costs and maintaining ecological responsibility. The packaging, with its insert system, featured flat-packing capabilities before filling, improving transport and storage efficiency.

The completed packaging adhered to standardized shelving dimensions, simplifying storage and organization in retail environments. Its unique shape supported visually appealing stacking methods (Figure 15), enhancing display aesthetics and practicality. The secondary packaging incorporated a friction-lock closure and tongue lock (Figure 13f) for easy, secure opening and closing, and included clear visual cues such as a half-circle cut mark for user guidance. The wider opening simplified the removal of the insert system, which featured an ergonomic grip designed with a tripod grasp in mind to suit the target audience's finger sizes. The primary packs were easily accessible by removing the top insert, and the sealed pouch opened effortlessly.

The insert system (Figure 10) consisted of three layers of angle-trigon shape boards with a locking mechanism that could be deconstructed into smaller components. This modular approach supported material separation, simplifying disposal and recycling. By saving space in waste management and enabling easy disassembly, the packaging reduced environmental impact and promoted sustainable practices throughout its lifecycle.

While polyethylene was chosen for the primary packaging due to its cost-effectiveness, the buffer and outer packaging utilized paperboard, an eco-friendly alternative that provided

*Contact: phone +94-771897206

DOI: [https://doi.org/10.31705/IDR.v1\(1\).2024.8](https://doi.org/10.31705/IDR.v1(1).2024.8)

Copyright © 2024, Integrated Design Research, Department of Integrated Design, University of Moratuwa, Sri Lanka

effective protection for fragile products. The recyclable and biodegradable properties of paperboard reinforced the project's ecological objectives.

In summary, the proposed packaging design successfully integrated lightweight, durable, and sustainable components, ensuring product safety, user convenience, and environmental responsibility. The iterative prototyping and testing approach highlighted the potential for improved protection, usability, and reduced ecological impact in packaging for fragile products. This study provides a strong foundation for future advancements in buffer packaging design.

References

- Dutt, D., Tyagi, C. H., Malik, R. S., Upadhyaya, J. S., & Kumar, D. (2003). Development of specialty papers is an art: Padding paper from indigenous raw materials – Part VIII. *Journal of Scientific & Industrial Research*, 62(10), 694–698. <http://nopr.niscair.res.in/bitstream/123456789/17624/1/JSIR%2062%2810%29%20996-1000.pdf>
- Gao, Z., Dong, W., & Xiaomin, J. (2021). Research on the reduction design of fragile product cushion packaging under the green development concept. *IOP Conference Series: Earth and Environmental Science*, 657(1), 012057. <https://doi.org/10.1088/1755-1315/657/1/012057>
- Ho, G. (2020, August 28). 3 packaging inserts and why they're important – LeKAC. LeKAC. <https://lekac.com/products/3-packaging-inserts-and-why-theyre-important>
- Kitazawa, H. (2018). Cushioning packaging for fresh produce. Reference Module in Food Science. <https://doi.org/10.1016/b978-0-08-100596-5.22483-9>
- Klein, M., Werner, C., Tacker, M., & Apprich, S. (2024). Influence of packaging design on technical Emptiability of dairy products and implications on sustainability through food waste reduction. *Sustainability*, 16(15), 6335. <https://doi.org/10.3390/su16156335>
- Kun, G., & Xi, W. (2017). Design and analysis of cushioning packaging for home appliances. *Procedia Engineering*, 174, 904–909. <https://doi.org/10.1016/j.proeng.2017.01.240>
- Lee, N. (2024). Shipping fragile items 101: How to ship fragile items. EFEX. <https://efex.vn/en/blog/shipping-fragile-items>
- Mindlin, R. D. (1945). Dynamics of package cushioning. *Bell System Technical Journal*, 24(3), 353–461. <https://doi.org/10.1002/j.1538-7305.1945.tb00892.x>
- Muhammad, A. (2024, October 7). What are packaging inserts? Intro to types, selection tips, & legal compliance. Refine Packaging. <https://refinepackaging.com/blog/what-are-packaging-inserts/>
- Nica, W., Roman, J., Slaets, P. et al. On the use of paper to facilitate recyclability of suspension packaging. *SN Appl. Sci.* 3, 828 (2021). <https://doi.org/10.1007/s42452-021-04810-2>
- Nupur Chopra, Divya Satyan, & Harleen Sahni. (2022). Evaluating Bubble Wrap and Proposing Post-consumer Textile Waste as Alternative Material: A review. *International Journal of Innovation and Business Strategy (IJIBS)*, 17(2), 51–74. Retrieved from <https://ijibs.utm.my/index.php/ijibs/article/view/124>
- Sexton, K. (2017, August 23). Packaging Realization. Packaging Strategies | Food and beverage market trends & solutions. <https://www.packagingstrategies.com>
- Sustainable cushioning to help you ship safely and in style. (n.d.). DSSmith.com UK. <https://www.dssmith.com/uk/products-services/packaging-solutions/retail-packaging/consumer-packaging/cushioning>
- Yang, X., Li, H., Sun, Y., Cai, Y., Zhou, H., & Zhong, F. (2023). Research on the design method of cushioning packaging for products with unbalanced mass. *Applied Sciences*, 13(15), 8632. <https://doi.org/10.3390/app13158632>

*Contact: phone +94-771897206

DOI: [https://doi.org/10.31705/IDR.v1\(1\).2024.8](https://doi.org/10.31705/IDR.v1(1).2024.8)

Copyright © 2024, Integrated Design Research, Department of Integrated Design, University of Moratuwa, Sri Lanka