

**A POWER SUPPLY RELIABILITY ASSESSMENT
MODEL FOR THE COLOMBO SUBURBAN
RAILWAY NETWORK**

D.T. Munasinghe

(168618V)

Degree of Master of Science

Department of Electrical Engineering

University of Moratuwa

Sri Lanka

August 2020

**A POWER SUPPLY RELIABILITY ASSESSMENT
MODEL FOR THE COLOMBO SUBURBAN
RAILWAY NETWORK**

D.T. Munasinghe

(168618V)

Thesis/Dissertation submitted in partial fulfilment of the requirements for the degree
Master of Science in Electrical Installation

Department of Electrical Engineering

University of Moratuwa
Sri Lanka

August 2020

DECLARATION

I declare that this is my own work and this thesis does not incorporate without acknowledgement any material previously submitted for a Degree or Diploma in any other University or institute of higher learning and to the best of my knowledge and belief it does not contain any material previously published or written by another person except where the acknowledgement is made in the text.

Also, I hereby grant to University of Moratuwa the non-exclusive right to reproduce and distribute my thesis, in whole or in part in print, electronic or other medium. I retain the right to use this content in whole or part in future works (such as articles or books).

Signature:

Date:

The above candidate has carried out research for the Master thesis under my supervision.

Signature of the supervisors:

Date:

Prof. Ranjith Perera

Signature of the supervisors:

Date:

Dr. Tilak Siyambalapitiya

DEDICATION

I dedicate my M.Sc. research dissertation to my beloved parents and my wife for their guidance given throughout my life.

ACKNOWLEDGMENT

I would like to sincerely thank my internal supervisor, Prof. Ranjith Perera, Department of Electrical Engineering, University of Moratuwa for the continuous support, encouragement and expertise in the field to make this Masters research a success.

I am really grateful to supervisor, Dr. Tilak Siyambalapitiya, Managing Director, Resource Management Associates (Pvt) Ltd. for being the originator of this research idea and for the guidance given to me to make this research a success.

I would like to thank the postgraduate research coordinator of department, Dr. Darshana Prasad for the supervision and management of research evaluation. I would like to pay my sincere appreciation to the academic staff of the Department of Electrical Engineering for their valuable feedback and constructive comments during progress reviews.

I would like to sincerely thank Eng. (Ms.) H.D.K. Herath, Electrical Engineer, Transmission Planning, Ceylon Electricity Board and Eng. (Ms.) Thotagamuwage Sajani, Junior Electrical Engineer, Colombo Suburban Railway Project for providing continuous support to get the required details for the project. I pay my special gratitude to Dr. H.M. Wijekoon Banda, Chief Engineer Transmission Planning, Ceylon Electricity Board and Eng. U.N. Sanjaya, Electrical Engineer, Transmission Planning, Ceylon Electricity Board for their support and guidance.

My heartfelt gratitude shall go to my family and friends who had been caring, supporting and facilitating me throughout the work.

ABSTRACT

An electrified railway network is one of the solutions for Colombo traffic congestion due to high population density and high daily passenger flow into the city from the suburbs. Although the initial cost of a railway electrification project is higher compared with other alternatives such as improvements to bus transport, energy, maintenance and operational costs can be lower if the system is designed, maintained effectively and used efficiently. System failures or, delays in system operations should be minimized to reduce the time wasted in traveling.

Reliability and punctuality are the major factors to attract more passengers to use public electrified transport facilities for their daily travel. Power supply is a critical factor to maintain a higher reliability in an electrified railway system.

Designs to upgrade the 230 km long Colombo suburban railway network commenced in 2017 and currently in progress in four stages. Different options for the power supply configuration and the back-up power systems have been identified, qualitatively evaluated and then recommended for implementation. A quantified reliability assessment has not been reported in the design.

A standardized procedure and a reliability assessment model would be required to evaluate the reliability of each optional configuration to supply power and backup power. In this research, optional configurations to supply power to the future electrified railway system of the Colombo Suburban Railway Project area were developed. Reliability assessment was conducted for each optional configuration using the models developed and simulated using Monte Carlo simulation technique. Reliability worth analysis was done to weigh the costs and benefits of configurations with higher reliability.

The model developed can be used for reliability assessment of the power supply to any suburban electrified railway system in Sri Lanka.

Keywords: Electrified Railway, Monte Carlo simulation, Reliability Assessment Model, Reliability Worth

Table of Contents

DECLARATION	i
DEDICATION	ii
ACKNOWLEDGMENT	iii
ABSTRACT	iv
Table of Contents	v
List of Figures	viii
List of Tables	ix
List of Abbreviations	xi
1. INTRODUCTION.....	15
1.1 Electrification of Sri Lanka Railway system.....	15
1.2 Power System Reliability	17
1.3 Research Motivation.....	18
1.4 Objectives of the study	19
1.5 Thesis outline.....	19
2. LITERATURE REVIEW	20
2.1 Power System Reliability Evaluation.....	20
2.2 Reliability Evaluation of Traction substations	20
2.3 Monte Carlo Simulation	21
2.4 Reliability Worth Assessment	22
3. PROPOSED METHODOLOGY FOR RELIABILITY EVALUATION	23
3.1 Power Supply Configuration	23
3.1.1 Sri Lanka Transmission Network.....	24
3.1.2 Selection Criteria for Power Supply Feeding Points.....	25
3.1.3 Power Supply Feeding Options for CSRP	25
3.1.4 Options for Back-up Power.....	27

3.2 Establishment of Reliability Assessment Models	29
3.2.1 Power System Reliability Evaluation techniques	30
3.2.2 Power System Hierarchical Levels	31
3.2.3 Reliability Assessment Indices	32
3.3.4 Reliability Assessment Model	33
3.3 Reliability Assessment of each Power Supply Configuration.....	35
3.4 Monte Carlo Simulation	37
3.4.1 Concept of Monte Carlo Simulation	38
3.4.2 Random Variates.....	39
3.4.3 Simulation Output	40
3.4.4 Reliability Evaluation of repairable systems.....	40
3.5 Reliability Worth Analysis	42
3.5.1 Customer Surveys and Customer Damage Function	43
3.5.2 Reliability Worth Assessment Techniques	43
4. DEVELOPMENT OF THE RELIABILITY EVALUATION MODEL	45
4.1 Grid Substation Modeling	45
4.2 Sub-Transmission System Modeling.....	47
4.3 Traction Substation Modelling	48
4.4 Establishment of an Integrated Reliability Assessment Model	51
4.5 Simplified Reliability Assessment Model	51
5. ASSESSMENT OF RELIABILITY INDICES AND WORTH ANALYSIS	54
5.1 Reliability Data and IEEE Standards.....	54
5.2 Transmission Network for CSRFP Feeding Options.....	55
5.3 Reliability Block Diagram of CSRN Feeding Options	57
5.4 Assessment of Reliability Indices.....	58

5.4.1 Reliability Assessment of CSRP feedings Options using Analytical Method	58
5.5.2 Monte Carlo Simulation.....	64
5.5 Reliability Worth Analysis	68
5.5.1 Optimized Power Supply Configuration.....	68
5.5.2 Blackout Relief Options.....	75
5.5.3 Reliability Benchmark for Power Supply Configuration of Electrified Railway in Sri Lanka.....	77
6. CONCLUSIONS AND FUTURE DIRECTIONS.....	82
6.1 Conclusions	82
6.2 Future Directions	82
REFERENCES.....	84
ANNEX A - SINGLE LINE DIAGRAM OF TRACTION SUBSTATION.....	88
ANNEX B - SUBSTATION LAYOUT FOR PROPOSED TRACTION SUBSTATION.....	89
ANNEX C - SRI LANKA TRANSMISSION SYSTEM IN YEAR 2018.....	90
ANNEX D - SCHEMATIC DIAGRAM OF 2017 TRANSMISSION SYSTEM...	91
ANNEX E - COLOMBO SUBURBAN RAILWAY NETWORK AND PROPOSED FEEDING SUBSTATION.....	92
ANNEX F - CSRP FEEDING OPTIONS FROM SCHEMATIC DIAGRAM OF THE 2022 TRANSMISSION SYSTEM.....	93
ANNEX G - RELIABILITY DIAGRAM OF CSRP FEEDING OPTIONS.....	94
ANNEX H - RELIABILITY INDICES EVALUATION OF KV LINE FEEDING OPTION ONE AND TWO.....	95
ANNEX I - RELIABILITY INDICES EVALUATION OF COASTAL LINE FEEDING OPTION THREE, FOUR AND FIVE.....	99
ANNEX J - RELIABILITY INDICES EVALUATION OF MAIN & PUTTALAM LINE FEEDING OPTION SIX, SEVEN AND EIGHT.....	109
ANNEX K - MONTE CARLO SIMULATION RESULT OF KV, COASTAL AND MAIN & PUTTALAM LINE.....	117

List of Figures

	Page
Figure 1-1 Proposed Colombo suburban electrified railway network	16
Figure 1-2 Subdivision of system reliability	17
Figure 3-1 Transmission network in CSRP area.....	24
Figure 3-2 GSS with proposed electrified railway network.....	26
Figure 3-3 Selected CSRP feeding arrangements	27
Figure 3-4 Power system hierarchical levels.....	32
Figure 3-5 Sub-transmission system	32
Figure 3-6 Series system with repairable components.....	34
Figure 3-7 Parallel system with repairable components	34
Figure 3-8 Sub-transmission network	36
Figure 3-9 Reduced sub-transmission network.....	37
Figure 3-10 Operating cycles of a two component parallel redundant system	41
Figure 3-11 Incremental reliability cost.....	42
Figure 3-12 Reliability and total system cost.....	42
Figure 4-1 GSS reliability model	45
Figure 4-2 Transmission line reliability model.....	47
Figure 4-3 Single line diagram of a TSS.....	49
Figure 4-4 TSS reliability model	49
Figure 4-5 Integrated power supply reliability model.....	51
Figure 4-6 Simplified reliability diagram of CSRN feeding options.....	53
Figure 5-1 Equivalent power supply configuration for coastal and KV lines.....	56
Figure 5-2 Equivalent power supply configuration of main & Puttalam lines	56
Figure 5-3 Reliability Diagram of CSRN feeding options	57
Figure 5-4 Reliability result of option one	65
Figure 5-5 Reliability result of option thee	66
Figure 5-6 Reliability results of option seven	66
Figure 5-7 Incremental reliability cost of main & Puttalam lines.....	71
Figure 5-8 Expected interruption cost of CSRN	79
Figure 5-9 Reliability worth curve.....	80
Figure 5-10 Minimum total cost analysis of CSRN.....	81

List of Tables

	Page
TABLE 3-1 SUMMARY OF REVISED FEEDING OPTIONS	26
TABLE 3-2 OUTAGES OF TRANSMISSION SYSTEM	28
TABLE 3-3 SUMMARY OF ADVANTAGES AND DISADVANTAGES	38
TABLE 4-1 EVALUATION OF LINE BAY IN GSS	46
TABLE 4-2 EVALUATION OF TRANSFORMER BAY IN A GSS	47
TABLE 4-3 EVALUATION OF THE TRANSMISSION LINE	48
TABLE 4-4 SYMBOLS OF SLD IN TSS	50
TABLE 4-5 EVALUATION OF TSS	50
TABLE 4-6 EVALUATION OF A GSS	52
TABLE 5-1 RELIABILITY DATA	54
TABLE 5-2 POWER SUPPLY FEEDING OPTIONS IN CSR.P.....	58
TABLE 5-3 RELIABILITY INDICES OF OPTION 1	58
TABLE 5-4 RELIABILITY INDICES OF OPTION 2	59
TABLE 5-5 COMPARISON OF RELIABILITY INDICES OF KV LINE	59
TABLE 5-6 RELIABILITY INDICES OF OPTION THREE.....	60
TABLE 5-7 RELIABILITY INDICES OF OPTION FOUR	60
TABLE 5-8 RELIABILITY INDICES OF OPTIO FIVE	60
TABLE 5-9 RELIABILITY INDICES COMPARISON OF COASTAL LINE.....	60
TABLE 5-10 RELIABILITY INDICES OF OPTION SIX.....	62
TABLE 5-11RELIABILITY INDICES OF OPTION SEVEN	63
TABLE 5-12 RELIABILITY INDICES OF OPTION EIGHT	63
TABLE 5-13 RELIABILITY INDICES COMPARISON OF MAIN & PUTTALAM LINE.....	63
TABLE 5-14 SUMMARY OF RELIABILITY INDICES EVALUATION OF ALL OPTIONS.....	63
TABLE 5-15 MCS SIMULATION RESULT	65
TABLE 5-16 SUMMARY OF EVALUATION OF RELIABILTY INDICES	67
TABLE 5-17 CAPTICAL COST ESTIMATE FOR OF KV LINE	68

TABLE 5-18 CAPITAL COST ESTIMATE FOR COASTAL LINE	69
TABLE 5-19 CAPITAL COST ESTIMATE FOR MAIN & PUTTALAM LINE	70
TABLE 5-20 REVENUE LOSS CALCULATION OF MAIN & PUTTALAM LINES	72
TABLE 5-21 FUEL COST AT INTERRUPTION DURATION.....	73
TABLE 5-22 EXPECTED INTERRUPTION COST USING CCDF.....	73
TABLE 5-23 EXPECTED INTERRUPTION COST USING EENS AND IEAR ...	74
TABLE 5-24 COST ANALYSIS OF BOR OPTIONS	76
TABLE 5-25 REVENUE LOSS CALCULATION OF CSRN FEEDING OPTIONS.	77
TABLE 5-26 EXPECTED INTERRUPTION COST OF CSRN USING CCDF	78
TABLE 5-27 EXPECTED INTERRUPTION COST OF CSRN USING EENS AND IEAR	78
TABLE 5-28 AVERAGE INTERRUPTION COST OF CSRN	78
TABLE 5-29 ANNUALIZED COST OF CSRN.....	79
TABLE 5-30 MINIMUM TOTAL COST CALCULATION OF CSRN	80

List of Abbreviations

Abbreviation	Description
AC	Alternative Current
BB	Bus Bar
CB	Circuit Breaker
CEB	Ceylon Electricity Board
CMR	Colombo Metropolitan Region
CSRN	Colombo Suburban Railway Network
CSRP	Colombo Suburban Railway Project
CT	Current Transformer
CVT	Capacitive Voltage Transformer
DMU	Diesel Multiple Unit
ET	Earthing Transformer
EDNS	Expected Demand Not Supplied
EENS	Expected Energy Not Supplied
EMU	Electric Multiple Unit
ES	Earth Switch
ETF	Earthing Transformer
FTA	Fault Tree Analysis
G&T	Generation and Transmission
GSS	Grid Sub Station
HL	Hierarchical Levels
HV	High Voltage
IEC	International Electro technical Commission
IEEE	Institute of Electrical and Electronic Engineering
ISO	Isolator
KV	Kelani Valley
LA	Lightning Arrester
LCC	Life Cycle Cost
LOLF	Loss of Load Frequency

LOLP	Loss of Load Probability
LV	Low Voltage
MCS	Monte Carlo simulation
MTTR	Mean Time to Repair
MV	Medium Voltage
NCRE	Non-Conventional Renewable Energy
NCT	Neutral Current Transformer
O&M	Operation and Maintenance
OCS	Overhead Contact System
PPTA	Project Preparatory Technical Assistance
RSI	Railway System Index
SCADA	Supervisory Control and Data Acquisition
SCC	System Control Centre
SL	Sri Lanka
TSS	Traction Substation
VT	Voltage Transformer

1. INTRODUCTION

1.1 Electrification of Sri Lanka Railway system

Traffic congestion in suburban areas of Sri Lanka is rapidly increasing which leads to higher transit time, less productivity and, substantial environment pollution, and becomes more expensive with rising fuel prices and falling exchange rates. Therefore, economical, effective and efficient public transport facilities are required urgently for Colombo Metropolitan Region (CMR). An electrified railway network is one of the solutions for Colombo suburbs due to high population density and high daily passenger flow into Colombo from the suburbs. The public can be influenced to utilize public transport rather than their private vehicles which is the main cause for growing road traffic in suburban areas, if comfortable, electrified railway services are available.

The concept of railway electrification was stated by Eng. D. J. Wimalasuendra, renowned engineer in engineering history of Sri Lanka, in 1918 in his technical paper titled, 'Economics of Power Utilization in Ceylon', [1]. The importance and advantages of railway electrification were presented through several proposals and discussions. However, even after one hundred years, feasibility studies are still being conducted to implement the project. Although the initial cost is higher compared with other alternatives such as bus transport, electrified railways have lower energy, maintenance and operational costs, if the system is designed, maintained effectively and used efficiently. It will enhance the social standards and comfort by reducing commuter fatigue. Most importantly, electrified railways offer a higher capacity for transport along a given traffic corridor, to serve peak-time passenger demand.

Electrification of the Sri Lanka railway system was initiated again under Colombo Suburban Railway Project (CSR) in 2016. The project is focused on upgrading and modernizing the existing network along the existing railway corridors, inclusive of electrification. Accordingly, the suburban electrified railway network is planned to be developed along four major corridors, namely the Main Line, Coastal Line, Kelani Valley (KV) Line and Puttalam Line, of a total route length of about 230km [2].

- Main Line - Maradana to Veyangoda (with possible extension to Rambukkana)
- Coastal Line - Fort to Panadura (with possible extension to Kalutara South)
- KV line - Maradana to Padukka (with possible extension to Avissawella)
- Puttalam Line - Ragama to Negombo

The pre-feasibility study of CSRP conducted 2017 identified passenger and freight demands for railways by 2025 and 2035, requirement of infrastructure development, passenger needs, hauling power transition from diesel to electric, utilization of electric power supply options, communication and signaling and status of land acquisition, etc. Figure 1-1 shows the proposed Colombo suburban electrified railway network with four major railway lines.



Figure 1-1 Proposed Colombo suburban electrified railway network

The final feasibility study report for KV line [3] covering technical feasibility, economic and financial assessment, poverty and social assessment, land acquisition and resettlement planning, environment assessment, detailed engineering design, etc. was published on December 2018.

1.2 Power System Reliability

The primary function of an electric power system is to provide electrical energy to its customers economically, at an acceptable degree of continuity and quality [4]. Random failures of equipment and the system affect the supply continuity and demand for electrical energy. Interruptions and failures directly affect end user satisfaction and revenue of the utility, which then are indirectly imposing a burden on the society and the environment. Reliability is a key factor for planning, designing, operation and maintenance of any power system.

A power system is very complex and highly integrated. Subdivision and functional zones are required to model and analyze the system. System adequacy and security are two basic aspects in power system reliability assessment. System adequacy is related to static conditions by providing sufficient facilities to satisfy the consumer demand and operational constraints within the system. System security is associated with dynamic conditions, by maintaining the ability of the system to respond to transient disturbances arising within the system [5-6].

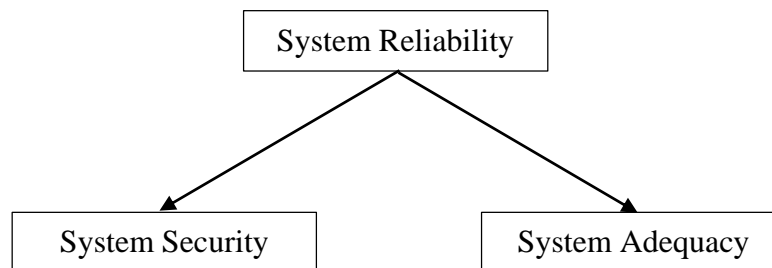

Figure 1-2 Subdivision of system reliability

Generation, transmission and distribution are basic functional zones for the purpose of analysis of the system adequacy. Furthermore, this division is used for organization, planning, operation, etc. Functional zones are combined to arrange hierarchical levels which are also used in adequacy assessment. Most reliability assessment techniques are used to evaluate the system adequacy, using past system performance such as system faults, equipment failures, etc. Requirements of power system adequacy assessment are dependent on the hierarchical levels.

In a decision-making process, economics of alternative facilities and their reliability should be considered. There are many approaches to evaluate the system reliability along with their economics such as investment cost, incremental cost of reliability, interruption costs, etc. Therefore, the concept of power system reliability encompasses all aspects of the ability of the system to satisfy the customer requirements and economics.

1.3 Research Motivation

Properly scheduled train services are compulsory in a railway system without inconveniencing the passengers. System failures or, delays in system operations should be minimized to reduce the time wasted in traveling and to build passenger confidence. Reliability and punctuality are the major factors to attract more passengers to use public electrified transport facilities for their daily travel.

Power supply is a critical factor to maintain a higher reliability in an electrified railway system. Different options for the power supply configuration and the back-up power system should be identified during the design stage, evaluated and then selected for implementation. A reliability assessment model would be necessary to assess the reliability of different configurations of power supply.

Different power supply configurations comprising traction substations, feeding points and upstream configurations are possible to deliver power to trains. In case of equipment failure or in case of a failure of the entire grid, back-up feeding arrangements, substations and generation too would have to be considered, based on the expected reliability of supply. Back-up generation may be owned by Sri Lanka Railways, Ceylon Electricity Board (CEB), or even an independent power producer. The distribution configuration has to be designed considering various factors such as cost, operation and maintenance capability, availability, etc.

Reliability should be quantified for each power supply configuration and for the back-up power supply, before commencing the project.

1.4 Objectives of the study

The main objective of this research was to develop a reliability assessment model to evaluate each power supply and backup supply configuration to serve the proposed electrified railway system. Economic assessments would be done using costs and benefits of each configuration. The following methodology was set out to achieve this main objective.

- Develop optional power supply configuration considering the existing electricity network in the Colombo Suburban Railway project area
- Identify back-up power supply options including back-up generation
- Establish reliability assessment models for each option
- Assess the reliability of each power supply configuration
- Simulate using Monte Carlo simulation techniques
- Compare costs and benefits of optional configurations

1.5 Thesis outline

The thesis is structured as follows, covering the achievement of the objectives set-out in section 1.4.

Chapter 2 provides a comprehensive review of literature related to power systems and traction substations, reliability indices, evaluation techniques, reliability and worth assessment. Chapter 2 also presents Monte Carlo Simulation as a probabilistic modelling technique.

Chapter 3 presents the methodology proposed to develop the reliability assessment models for Colombo Suburban Railway.

Chapter 4 presents reliability assessment model development and model simplification to evaluate reliability of each power supply and backup supply configurations.

Chapter 5 includes reliability assessment of CSRP feeding options using the model developed and simulation result using Monte Carlo simulation. Further, results of reliability worth analysis are discussed in this chapter.

Chapter 6 presents the conclusions and future directions of the study.

2. LITERATURE REVIEW

2.1 Power System Reliability Evaluation

Numerous studies have been carried out for evaluation of power system reliability using different techniques and to improve existing techniques. In the literature review, the main focus was on reliability evaluation of transmission systems and bulk power systems.

To evaluate transmission system reliability, the following models and methods have been used,

- Analyzing the annual undersupply of energy and annual cost of undersupply energy, considering failures of all components in a transmission system, and failures in protection schemes of autotransformers and lines [7].
- Developing three loops (substation, transmission and bus) to model the transmission system and identify the loop outage state and delivery point outage state. Outage time, outage frequency and outage range have been used as the loop index [8].

The following studies have been carried out to evaluate bulk power system reliability

- Developing a method to calculate failure probability, frequency and duration of bulk power systems, using state and contingency enumeration and effect analysis (Quadrated power flow model and remedial actions) with security evolution approach. [9-10]
- Integrating reliability evaluation of Generation and Transmission (G&T) network, sub-transmission network and distribution network using contingency enumeration, series and parallel network method and the failure mode and effect analysis (FMEA), respectively [11].

2.2 Reliability Evaluation of Traction substations

Traction substations are directly incorporated into an electrified railway. Therefore, reliability evaluation of the electrified railway network must be done by considering the reliability of traction substations. The following studies are typically carried out for reliability evaluation of electrified railway networks.

- Five analytical expression (LOLP, LOLF, EDNS, EENS, and RSI- Railway System Index) are used for evaluation of the reliability indices of electrified railway with sensitivity analysis [12].
- Establishing a simulation model of traction power supply system in the MATLAB/Simulink, to simulate different fault conditions for analyzing of the required protection schemes [13].
- Evaluating the reliability based on FEMA modeling approach using TARAS software and calculating a total failure rate of the traction system [14].
- Assessing the de-rating requirement of traction transformers, considering the imbalance, impact and nonlinearity of traction load. Using a thermal circuit model, obtaining transformer hotspot temperature and quantifying the traction load characteristics. Arrhenius-Weibull model and load characteristic were used to evaluate the reliability of the traction transformer. [15]
- Analyzing the development of standards and guidelines for traction power systems [16].
- Evaluating the reliability of railway power system using fault tree analysis (FTA) and investigating the impact of maintenance activities on overall reliabilities. FTA was integrated with reliability evaluation of individual critical components which were identified using minimum cut set and sensitivity analysis [17].

2.3 Monte Carlo Simulation

Monte Carlo simulation (MCS) are widely used for reliability evaluation in power systems. This simulation method can be used on any kind of structure and operating condition without using modelling assumptions practiced in analytical methods.

Spreadsheet software enable simple applications to conduct MCS. A three-component system was analyzed though the MCS and detailed the application of spreadsheets for this simulation. Thereafter, a loop structure was solved by incorporating spreadsheets and MCS, and compared with the analytical results [18]. In reliability assessment in a bulk power system, the Monte Carlo simulation or the contingency enumeration method are used. There are various advantages and drawbacks in both methods. The real power system was used to illustrate the feasibility of these methods and their benefits in different scenarios such as generation, transmission, composite and other

assessment [19]. To assess the reliability indices including frequency and duration of interruption of composite generation and transmission systems, sequential and non-sequential methods of Monte Carlo simulation such as state sampling and state transition sampling can be effectively used. These three simulation approaches have been compared using practical test system and presented with enumeration process results [20]. Improved Monte Carlo simulation method combined with parallel calculations were also introduced for improvement of calculation efficiency using the important sampling method combined with latin hypercube sampling method. IEEE RTS79 node system and equivalent simplified system were used to verify the accuracy and efficiency of results in the new method [21].

2.4 Reliability Worth Assessment

Reliability worth assessment is an important analysis for planning and operation of a power system. It is also a common platform for the decision making process in power system reliability evaluation. The most challenging part of this analysis is establishment of customer benefits such as costs of interruption.

To develop two cost models comprising a probabilistic distribution model (PDM) and an average or aggregate model (AAM), cascade correlation neural network (CCNN) have been utilized. Then a radial network was used to test the proposed models by evaluating the reliability worth and to identify the most realistic model [22]. An analysis of reliability and life cycle costs of two different scenarios was discussed, which were a single bus bar in two sections and a double circuit breaker system with double bus bars, and compared using a 400kV substation model [23]. A new method has been proposed to select the main electrical connection in different power grid development periods using investment cost function and minimal cut-set reliability model combination. Systems rated at 110kV and 220kV have been used to analyze and compare advantages and disadvantages of this method [24].

3. PROPOSED METHODOLOGY FOR RELIABILITY EVALUATION

3.1 Power Supply Configuration

Identification all possible power supply feeding options for electrified railway system considering the existing electricity network in Colombo suburban railway network (CSRN) area was the first objective of this research. The present power system in Sri Lanka was studied to assess the present condition of the transmission and distribution system. The generation and transmission planning reports [25], [26] published by CEB provide information on the present and planned future power system in the country.

Sri Lanka power system comprises around 4000MW of installed generating capacity serving 2500MW at night peak. Generation of electricity is diversified among hydropower (34%), thermal (Oil CEB –14.8%, IPP – 15.4%), thermal (Coal, 22%), and NCRE (13.8%). The distribution system operates at 33 kV and 11 kV spanning about 32,863 km, serving medium and large customers. Electricity is served to the end users at 400 V (line-to-line), fulfilling the needs of 6,193,131 retail customers around the country [27], [28]. Details of the transmission network are discussed in section 3.1.1.

According to the feasibility study of CSRP and other published research [29], a classic single phase 25kV Overhead Contact System (OCS) has been proposed, served with Scott–T transformer configured traction substations (TSS). A traction substation converts the higher voltage electricity from the utility to 25kV single phase electricity and supplies it to electric locomotives through the catenary system. A Scott–T transformer is used as the traction transformer because of its capability of minimizing the voltage unbalance and voltage drop on the primary side of the transformer. Permissible maximum and minimum voltages of TSS are 27.5kV and 19kV, and the required phase to phase and phase to earth clearance on the 132kV and 25kV sides are 1350mm and 325mm, respectively.

According to the typical traction power architecture, a TSS comprises two transformer bays, a single bus bar arrangement and four feeder bays, to increase the redundancy of the system. One transformer can serve the total TSS load and the other

one will be a spare. The typical single line diagram and the layout of a proposed TSS are provided in ANNEX-A and ANNEX-B, respectively.

3.1.1 Sri Lanka Transmission Network

CEB is the sole transmission licensee, and the system functions on the basis of a single buyer model. This means a licensed generator may sell only to CEB, and customers at transmission level and the distribution licensees, should purchase electricity only from CEB. The System Control Centre (SCC) plans and carries out day to day operations of the generation and transmission system, to serve the customer demand, fulfilling objectives of reliability, quality of power and operational economy.

The transmission network is operated at 220 kV and 132 kV with transmission lines spanning around 600 km and 2310 km, respectively. Approximately, 60 grid substations around the country are fed through the transmission network [27], [28]. Figure 3.1 shows the transmission network in CSRP area with grid substations and generation plants. The map of Sri Lanka transmission system in year 2018 is provided

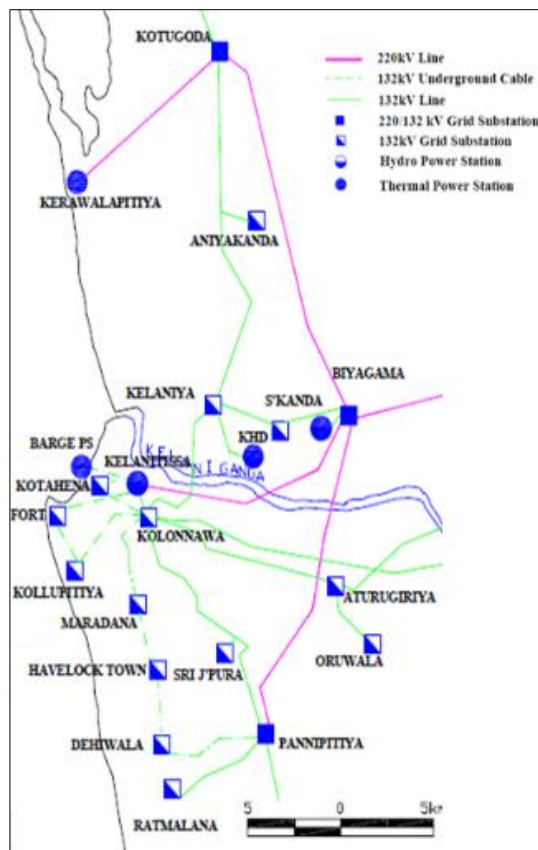

Figure 3-1 Transmission network in CSRP area

in ANNEX–C and schematic diagram of 2017 transmission system is provided in ANNEX–D.

3.1.2 Selection Criteria for Power Supply Feeding Points

Selection of power supply feeding points to the proposed electrified railway network was the critical in three main perspectives. The fourth perspective is land acquisition, since 100-150m² of enclosed area is required for each TSS. First perspective is power system quality. The following aspects are relevant under this perspective.

- Permissible minimum voltage level
- Fault levels, which will mitigate the potential adverse effects of unbalance arising from the single-phase electric traction loads.
- Long term demand growth

The second perspective in selecting criteria of power supply feeding points is the railway electrification perspective, for which the relevant points are,

- Convenience of feeding adjacent lines or branch lines
- Locating the TSS to withstand a 100-year flood
- Locating the TSS near the load center
- Viability of feeding 25kV over a distance of around 20km from the TSS, in each direction

The power supply reliability is the third critical perspective when selecting power supply feeding points. It will be discussed in later chapters.

3.1.3 Power Supply Feeding Options for CSRP

Potential sources for feeding power to CSRP network have been identified in the pre-feasibility study. Some feeding sources were revised after discussing with CEB, owing to lower diversity and reliability in selecting criteria of the supply. Revised feeding options were published in the final feasibility study report for KV line.

Table 3-1 summarizes the amendment of proposed power supply feeding options in pre-feasibility and final feasibility study for KV line. Figure 3.2 shows the selected GSS, Pannipitiya, Aniyakanda, Dehiwala and Ratmalana as power supply feeding

options to the CSRP network. The detailed map is provided in ANNEX-E. Figure 3.3 illustrates the selected CSRP feeding options with distance between the GSS and electrified railway line.

TABLE 3-1 SUMMARY OF REVISED FEEDING OPTIONS

Electrified Railway Line	Feeding Options		Remarks
	Pre-feasibility	Final feasibility for KV line	
KV line	Pannipitiya, Kosgama	Pannipitiya	1. Kosgama for supporting Awissawella extension which will be in the second phase.
Coastal line	Ratmalana	Mid location between Ratmalana and Dehiwala	1. No diversity with Ratmalana 2. Less reliability with Ratmalana
Main & Puttalam lines	Kelaniya	Aniyakanda	1. Kelaniya is too close to Coastal and KV lines 2. Aniyakanda can serve both lines 3. Lower fault level with Aniyakanda

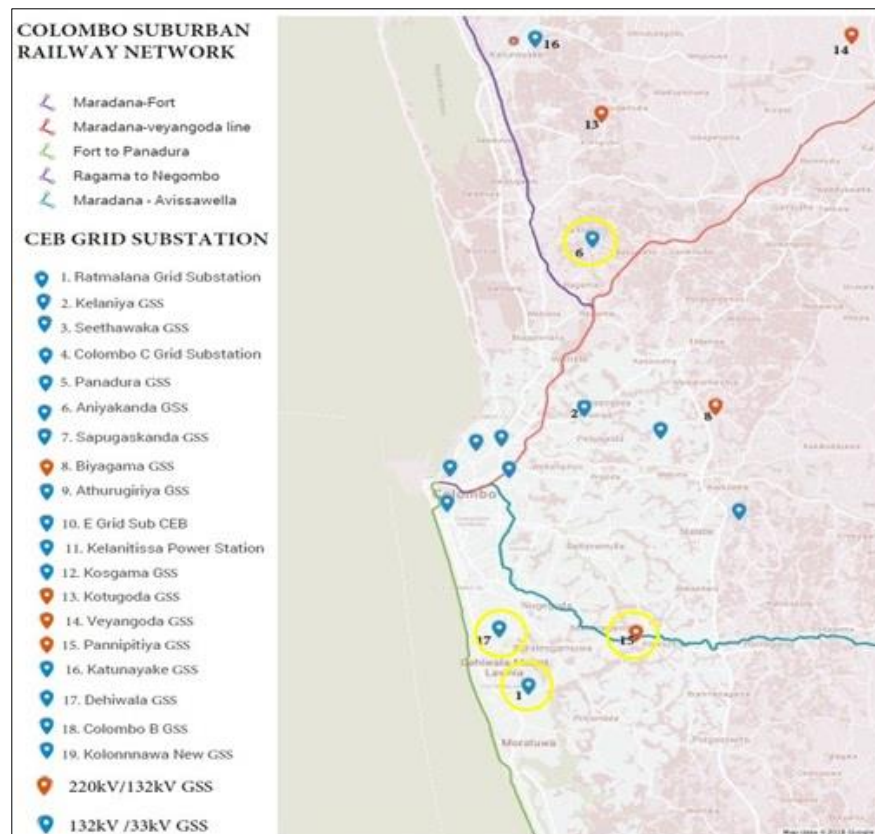

Figure 3-2 GSS with proposed electrified railway network

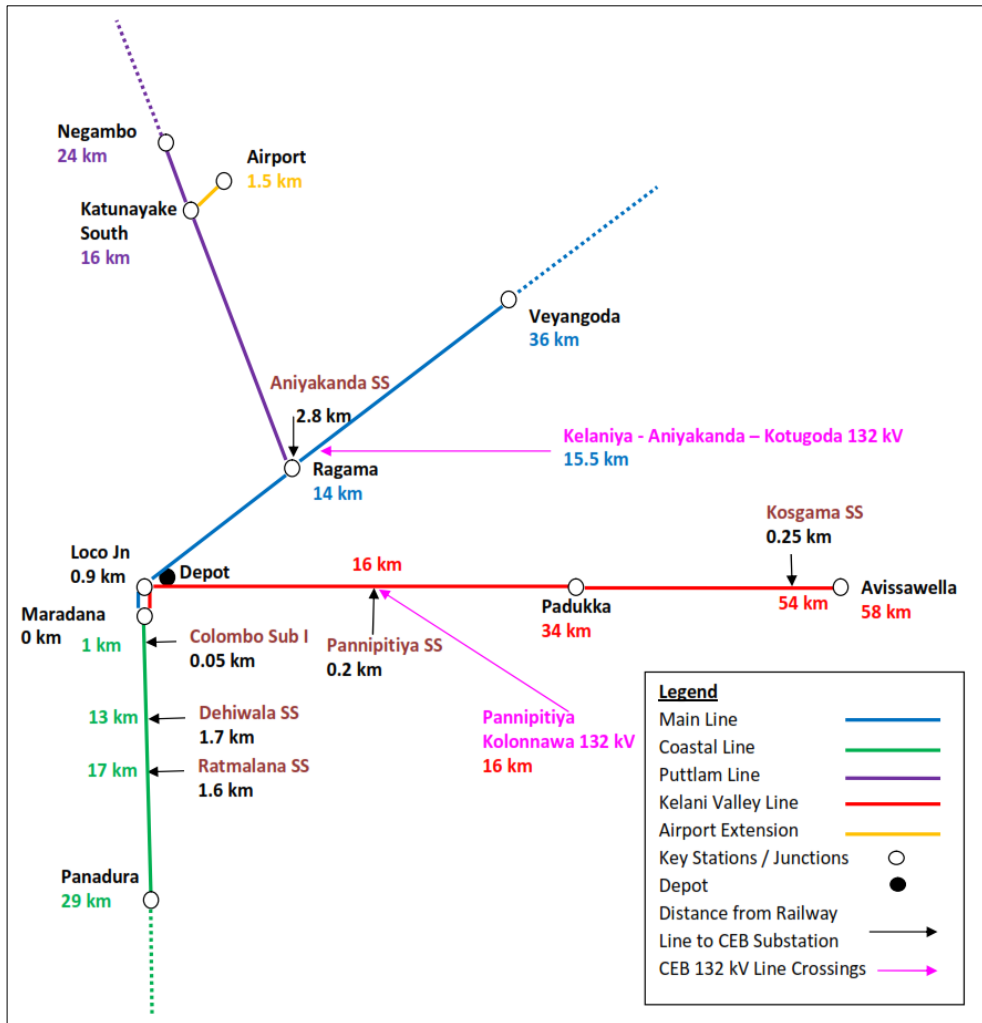

Figure 3-3 Selected CSRP feeding arrangements

3.1.4 Options for Back-up Power

To maintain an electrified railway system at a higher reliability, the reliability power supply is the most critical factor. Electric train operations will be completely dependent on power supply from CEB, for traction power, communication and signaling. Unplanned power interruptions may happen at any time of the day, peak or off-peak. In the recent past, the power system of Sri Lanka experienced three total blackouts. In September 2015, a 5-hour blackout was encountered. In 2016, two total system collapses occurred in February and March, persisting for 3 hours and 7 hours, respectively.

When an interruption occurs, trains require to continue towards the next station with authorization from the signaling system and safely de-train the passengers. Thus, the

railway signaling and communications subsystems should have dedicated UPS and/or diesel generator back-up, to maintain their general and emergency functions without disturbance. A stable communication and control system will assist in managing impacts of power interruptions by supporting the staff in train operations and safety.

Although total system failures have not been reported since March 2016, a number of unplanned interruptions have occurred in the transmission system. Table 3-2 summarizes outages of the transmission system in 2017 and 2018.

TABLE 3-2 OUTAGES OF TRANSMISSION SYSTEM

Transmission System	Voltage Level (kV)	Total Outage Duration (h)	
		2017	2018
Transmission Lines	132	140.73	393.12
	220	37.62	48.80
Cable Lines	132	4.88	7.18
	220	12.10	4.32

In the final feasibility study report of the KV line, the following Black out Relief (BOR) options are presented.

- Temporary reduction of capacity of supply from the unaffected CEB source to allow limited power supply to railways
- Autonomous generating plant with the required output, single phase 25kV
- Autonomous stored energy plant or backup battery capacity on-board Electric multiple units (EMUs)

Autonomous generating and energy storage facilities are very expensive in comparison with option one. However, those options may be more effective when considering high reliability expected of electrified railway transport. In the present condition, option one has been considered to be the most cost-effective and practical solution for the KV line.

The feasibility study has considered options to serve CSRN in case of a total blackout. Discussions are going on to obtain a prioritized power supply from Colombo Substation I (from Kelanitissa Gas Turbine Power Plant via Kolonnawa GSS) to serve CSRN during a blackout, until the grid is restored. Although KV line report highlights

that Colombo sub I will serve only the KV line, this alternative power source can be configured to supply the total network during a blackout, for moving a limited number of trains at a time. These options will be finalized and enhanced in the detailed engineering studies of CSRN.

3.2 Establishment of Reliability Assessment Models

Primary function of power system is to supply electrical energy to its end users economically and an acceptable degree of continuity and quality [5]. Reliability is “*the probability of a device/system performing its purpose adequately for the period of time intended under the operating conditions encountered*” [4]. The following basic breakdowns are in the definition:

- Probability, provides the numerical input for the assessment of reliability and the first index of system adequacy
- Time intended, may be continuous or very sporadic
- Operating conditions, may be perfectly uniform or extremely variable
- Adequate performance, may be a catastrophe or a complete failure to operate, or it may be caused by a violation of the required system function

For continuously operated systems, the measure is used as ‘availability’, which is interpreted as “*the probability of finding the component/device/system in the operating state at some time into the future.*”

Power supply is a critical factor to maintain a higher reliability in an electrified railway system. Reliability of the power supply to an electrified railway can be defined as its ability to continuously supply electrical power of adequate quality during sudden disturbances such as a short circuit or loss of system elements, while operating with a normal or scheduled maintenance and repair scheme configuration, without causing safety hazards, train delays or public nuisance.

Power system reliability can be evaluated using analytical methods and the Monte Carlo simulation (MCS) method, which will be discussed in detail in section 3.2.1 and section 3.4, respectively [11]. A reliability assessment model was required to evaluate the reliability of different configurations of power supply, using the analytical method.

Transmission lines, grid substations and traction substations are the main sub-system in the power supply configuration of the electrified railway network. Integration of these sub-systems were required to develop the reliability assessment model. The model was then simplified using assumptions, while avoiding loss of system parameters and ending with results that are good approximations.

3.2.1 Power System Reliability Evaluation techniques

Quantitative evaluation of reliability of a system or device is used for assessment of past performance and prediction of future performance. These assessments are valuable for different approaches. It can be identified weaknesses, chronological trends and acceptable operating indices of the system. It will be helpful for future expansions and modifications.

Analytical techniques and simulation techniques are main categories of quantitative assessment of reliability. Analytical techniques are used to evaluate reliability indices using mathematical solutions and represent the system using a mathematical model. In this research, an integrated simplified reliability assessment model for electrified railways was developed, using analytical techniques. Monte Carlo simulation is one of the reliability simulation techniques which estimates the reliability indices by simulating the actual process and random behavior of the selected system. Monte Carlo simulation will be discussed in section 3.4.

The most common analytical techniques for reliability assessment and network modeling are performed using following network reduction techniques.

- Simple systems – series and parallel networks
 - Series systems
 - Parallel systems
 - Series - parallel systems
 - Partially redundant systems
- Standby redundant systems
- Complex system - meshed networks
 - Conditional probability approach
 - Cut set method

- Tie set method
- Connection matrix techniques
 - Event tress
 - Fault trees
 - Multi –failure mode
- State space method
- Contingency enumeration method

In this research, to establish the reliability assessment model for electrified railways, partially redundant systems and series – parallel systems for simple networks and conditional probability approach technique for complex, meshed networks were used appropriately.

3.2.2 Power System Hierarchical Levels

For adequacy assessment in reliability analysis, thee functional zones and hierarchical levels were considered separately due to complexity of the total network. Power system hierarchical levels are as follows. Figure 3.4 shows power system hierarchical levels.

- Hierarchical level I (HL I) - Only generation and load of the system
- Hierarchical level II (HL II) - Bulk power system (generation and transmission)
- Hierarchical level III (HL III) - whole power system (generation, transmission and distribution)

Hierarchical level II (HL II) evaluates the generation and transmission capacity to supply the system load. Reliability evaluation of HL II includes two aspects, which are reliability evaluation of generation and transmission (G&T) network and reliability assessment of sub-transmission network. Contingency enumeration method and series and parallel network reduction method were used to evaluate G&T network and sub-transmission network, respectively. The sub-transmission network is the connection between the G&T network and the distribution network. In the Sri Lankan context, generation and the 220kV transmission network was considered as the G&T network and the 220/132kV grid substation (GSS), 132kV transmission lines, 132kV cable lines and traction substations (TSS) were considered to be the sub-transmission

network. Figure 3.5 shows an equivalent sub-transmission system, considering the power supply configuration to the railway network.

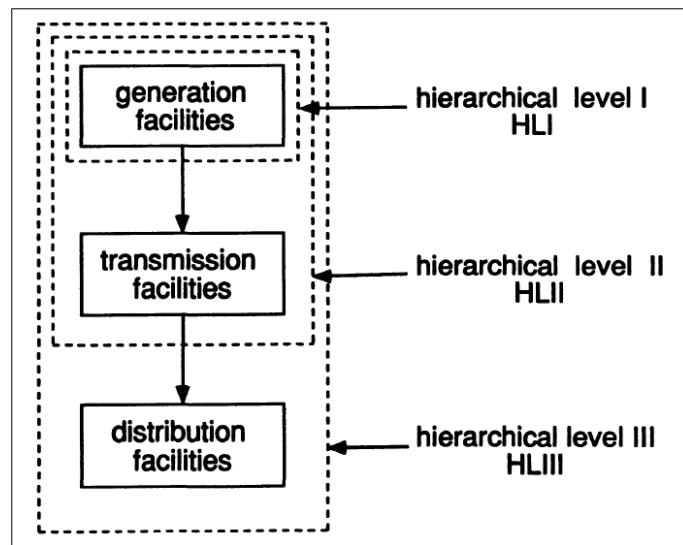

Figure 3-4 Power system hierarchical levels

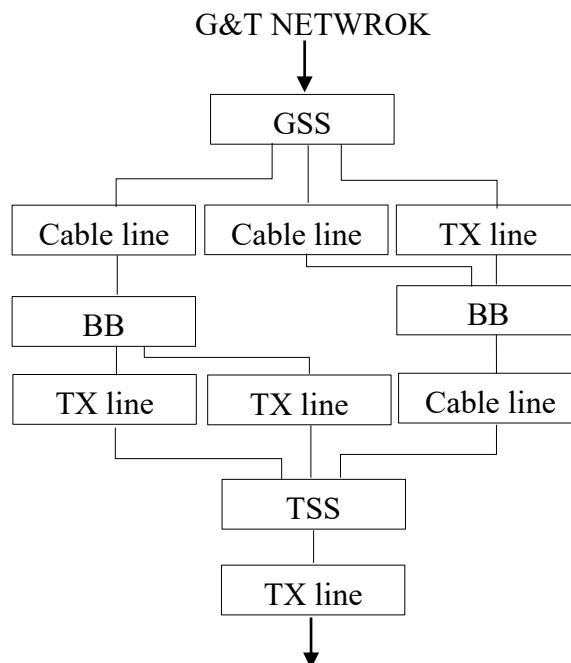

Figure 3-5 Sub-transmission system

3.2.3 Reliability Assessment Indices

Different kinds of adequacy indices in reliability assessment are used according to the hierarchical levels and the purpose of the analysis. Reliability indices reflect the

system component availability, capacity, system configuration and operational conditions and uncertainty.

In hierarchical level one, loss of load expectation (LOLE), loss of energy expectation (LOEE), loss of load frequency (LOLF) and loss of load duration (LOLD) are basic reliability indices in a generation system. These indices can be calculated using both Monte Carlo simulation and analytical techniques or using mathematical expressions. The following reliability indices are adequate to be used in hierarchical level two and distribution, respectively.

- Hierarchical level II – Bulk power system
 - Expected Demand Not Supplied (EDNS)
 - Expected Energy Not Supplied (EENS)
 - Average Failure Rate – λ (failures per year)
 - Average Outage Time – r (hours per failure)
 - Interruption duration – U (hours per year)
- Distribution System
 - System Average Interruption Frequency Index (SAIFI)
 - System Average Interruption Duration Index (SAIDI)
 - Customer Average Interruption Frequency (CAIFI)
 - Customer Average Interruption Duration Index (CAIDI)

3.3.4 Reliability Assessment Model

Transmission line, grid substation and traction substation are the key sub-systems in the power supply configuration of electrified railways. These three sub-systems can be independently modeled and then put in series to form the final model. Detailed individual and integrated model development will be discussed in section 4.0.

A power system is a highly integrated complex system. Series and parallel simplification and conditional approach methods were used in analytical model development. Failure rate, λ , stated in failures per year, mean time to repair (MTTR) given in hours, annual interruption duration, u given in hours per year and availability are the main reliability indices estimated using the model. Simplifications were done making typical assumptions which will be discussed in section 4.6.

System components were connected in series, parallel and meshed combinations. A simple system with series/parallel, combinations can be modelled using approximate equations, which were derived based on the Markov approach. For more complex systems that cannot be broken into series/parallel configurations such as the bridge network, the conditional approach method was used for reducing the network.

The sub-transmission system network can be reduced to series/parallel systems, ignoring the switching time of circuit breakers. The following approximate equations were used to evaluate average failure rate λ , MTTR, average repair time, r and average annual interruption duration, u of the network.

Figure 3.6 shows an n-component series system, where λ_s and r_s denote the overall failure rate and overall MTTR of a single component equivalent to the n-component in series. The product, λ_s, r_s for individual components is in practice so small that $\lambda_1 r_1 \lambda_2 r_2 \ll \lambda_i r_i$, for $i = 1, 2$. With this valid assumption λ_s, r_s , and u_s are given by (1), (2) and (3). Figure 3.7 shows the 2-component parallel system

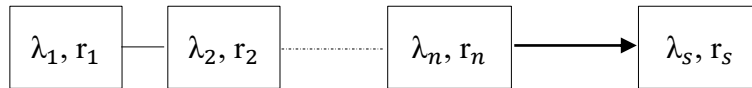

Figure 3-6 Series system with repairable components

$$\lambda_s = \sum_i^n \lambda_i \quad (1)$$

$$r_s = \frac{\sum_i^n \lambda_i \times r_i}{\lambda_s} \quad (2)$$

$$u_s = \lambda_s \times r_s \quad (3)$$

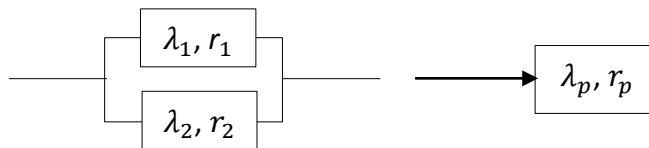

Figure 3-7 Parallel system with repairable components

The failure rate λ_p , the MTTR r_p and annual interruption duration of the single equivalent component are given in (4), (5) and (6) based on the assumption $\lambda_1 r_1$ and $\lambda_2 r_2$ are much less than unity.

$$\lambda_p \cong \lambda_1 \lambda_2 (r_1 + r_2) \quad (4)$$

$$r_p = r_1 r_2 / (r_1 + r_2) \quad (5)$$

$$u_p = \lambda_p \times r_p \quad (6)$$

Reliability evaluation of a sub-transmission system was done based on the assumption that the system operates with all components in service until a forced outage occurs. Interruption duration, availability and reliability of each configuration can be evaluated using (7), (8) and (9).

$$\text{Annual Interruption Duration (min/yr)} = \lambda \times r \times 60 \quad (7)$$

$$\text{Availability} = 1 - \left(\frac{\lambda \times r}{8760} \right) \quad (8)$$

$$\text{Reliability} = e^{-\lambda t} \quad (9)$$

These are basic concepts and equations to develop the reliability assessment model for electrified railways.

3.3 Reliability Assessment of each Power Supply Configuration

The reliability assessment model was used to assess the power supply reliability of the proposed Colombo Suburban Railway Network (CSRN) in Sri Lanka. The assessment model was validated by calculating reliability indices in four major lines and comparing the result with simulation results obtained from the Monte Carlo simulation. The following different scenarios from the Main & Puttalam lines, coastal and Kelani Valley (KV) lines in CSRN were considered in the case study.

- KV line
 - Locating the TSS within the Pannipitiya GSS
 - Locating the TSS near the railway line and feeding from Pannipitiya GSS
- Coastal line
 - Feeding the TSS from both Ratmalana and Dehiwala GSS
 - Feeding the TSS only from Ratmalana GSS
 - Feeding the TSS only using from Dehiwala GSS
- Main & Puttalam lines
 - Feeding to the TSS using the existing network

- Feeding the TSS using a line in and out connection from Kotugoda - Kelaniya 132kV line
- Locating the TSS at Wanawasala and feeding from Kelaniya GSS

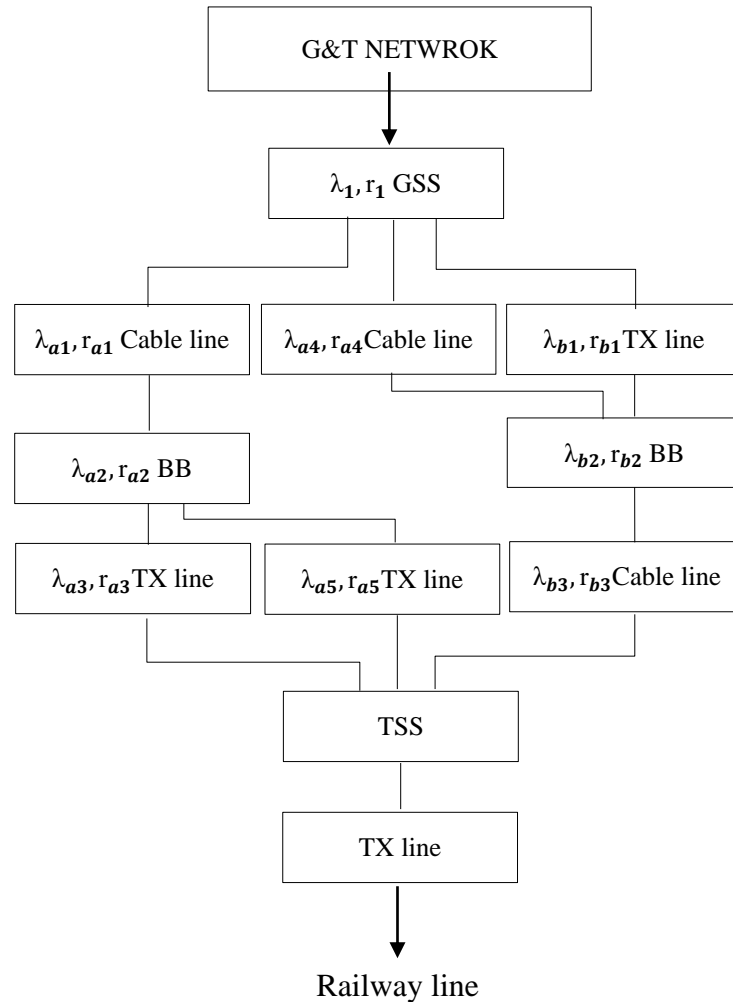

Figure 3-8 Sub-transmission network

Figure 3.8 shows the sub-transmission network planned for supplying the railway system. Figure 3.9 displays the reduced network using network reducing techniques, series/parallel system and conditional approach techniques. Failure rate and MTTR of GSS, transmission/cable line and TSS were calculated using the simplified model developed, and the integrated power supply reliability model.

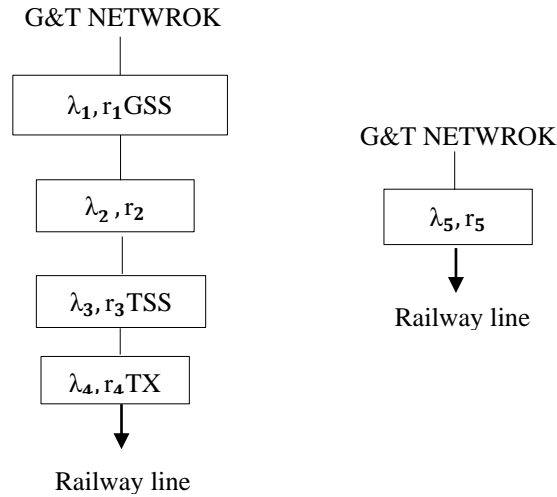

Figure 3-9 Reduced sub-transmission network

Final interruption duration, availability and reliability of each configuration can be evaluated using (7), (8) and (9) as follows.

$$\text{Interruption Duration (min/yr)} = \lambda_5 \times r_5 \times 60$$

$$\text{Availability} = 1 - \left[\frac{\lambda_5 \times r_5}{8760} \right]$$

$$\text{Reliability} = \exp(-\lambda_5 t)$$

Similarly, reliability indices were calculated for each power supply configuration of CSRN and compared with selected simulation results from Monte Carlo simulation.

3.4 Monte Carlo Simulation

Monte Carlo is a stochastic simulation approach in reliability evaluation which estimate the probability and reliability indices by simulating the actual process and its random behavior. The concept of the Monte Carlo simulation is the generation of random numbers and count the number of occurrences with repeating random generation. Simulation results depend on the random number generator and the number of independent generators used. There are differences and similarities in both analytical and simulation approaches in reliability evaluation. Table 3-3 summarizes advantages and disadvantages of each evaluation methods [5].

Stochastic simulations may be conducted using one of the two following approaches. The relevant approach is used according to system characteristics.

- Random approach - the basic intervals of the system lifetime by choosing intervals randomly
- Sequential approach - the basic intervals in chronological order

TABLE 3-3 SUMMARY OF ADVANTAGES AND DISADVANTAGES

Analytical techniques	Simulation techniques
The solution time is relatively short	Usually extensive
Always give the same numerical result for the same system, same model and same set of input data	Results depend on the random number generator used and the number of simulations
The model is usually a simplification of the system, sometimes to an extent that it becomes totally unrealistic	Can incorporate and simulate any system characteristic that can be recognized.
Output parameters are usually limited only to expected values.	Provide a wide range of output parameters including all moments and complete probability density functions

3.4.1 Concept of Monte Carlo Simulation

In real time, the behavior patterns of two systems differ from each other although they are identical in number of failures, restoration time, etc. That is due to the random behavior of the system. Therefore, simulations can be used to examine and predict real behavior of the system in simulated time. Then, the following are obtained as final outcomes,

- The frequency/probability distributions of various reliability parameters
- The expected or average value of each of the parameters

In Monte Carlo simulation, results indicate the following key features,

- A large number of simulations are required to produce a better estimate of the probability
- When the number of simulations is increased, oscillations of the probability value will gradually reach the true value

- The mean value of oscillations is not an acceptable estimate of the true value
- Sometimes, the true value is given during the simulation process, but the last value of the probability in the simulation is considered to be the estimate

Following aspects should be specifically considered, when generating and converting random numbers for simulation.

- The occurrence of events follows the inherent behavior of the components and variables contained in the system
- The occurrence of the events depends upon models and probability distributions used to represent the components and variables

3.4.2 Random Variates

Generation of random numbers is the first step of the simulation process. Random number is a uniformly distributed variable in the interval (0, 1). Random numbers are produced using deterministic algorithms in digital computers which are called random generators. Basic characteristic of random generators are randomness, uniform distribution, reproducibility, high computational efficiency and sequence repeats. Congruential generator is most popular algorithm to produce random numbers. Mixed congruential and multiplicative generator are two types in this algorithm. Following expression is used to create random numbers according to this algorithm. The multiplier, the modulus and the increment are denoted by A , B , C respectively which are non-negative integers.

$$X_{i+1} = (AX_i + C) / (\text{Mod } B)$$

After generating the sequence of random numbers X_i , a uniform random number U_i can be produced using the following expression.

$$U_i = X_i / B$$

In addition, there are numerous algorithms to generate random numbers and uniform random numbers. Non-uniform distributed random numbers are required for some types of simulations. Following techniques are used to convert uniform random numbers into a non-uniform distribution.

- Inverse transform method
- Composition method
- Acceptance rejection method

If the distribution can be inverted analytically, the inverse transform method can be used efficiently otherwise other conversion methods are used. In inverse transform method, uniform random variable U can be transformed using the following expression where failure rate, $\lambda \geq 0$ and $t \geq 0$.

$$T = -\frac{1}{\lambda} \ln U$$

3.4.3 Simulation Output

At the end of the simulation process, N estimates are produced for each of the parameters which should be assessed. N is the number of performed simulation. Following two ways are ordinarily used to process these estimates. The first method was used frequently to present simulation outputs in this thesis.

- Plots of the distributions such as frequency histograms or density functions which,
 - provide a clear graphic representation in variation of the parameters
 - show schematic representation of very skewed distribution
 - can be constructed easily
- Point estimates such as means, modes, minima, maxima, percentiles which,
 - are frequently used in reliability assessment and decision-making process
 - are calculated directly from the parameter values
 - are only estimates of the exact value

3.4.4 Reliability Evaluation of repairable systems

Monte Carlo simulation can be used to evaluate reliability and availability in time dependent systems, non-repairable systems, repairable systems and standby systems. In this research, the simulation process was used to evaluate the reliability of repairable systems. Therefore, this section briefly describes the steps in the simulation process of the reliability evaluation of repairable systems. The following steps were used in the

simulation process. A sequence of operating-repair cycles of each component of the system were simulated [6].

1. Generating a random number
2. Converting this number into a value of operating time using a conversion method on the appropriate times-to-failure distribution
3. Generating a new random number
4. Converting this number into a value of repair time using a conversion method on the appropriate times-to-repair distribution
5. Repeating steps 1-4 for a period equal to or greater than the required mission time
6. Repeating steps 1-5 for each component in the system
7. Comparing the sequences for each component
8. Repeating steps 1-7 for the desired number of simulations

The system was considered to be a successful operating system, if there were no overlapping repairs during the expected time period. If repair of both components overlapped during the expected time period, the system was considered to be a failure. Figure 3.10 illustrates two-component parallel redundant system operating cycles. Simulated time to failure and expected simulation times are denoted by T_F and T_{M1} , T_{M2} respectively.

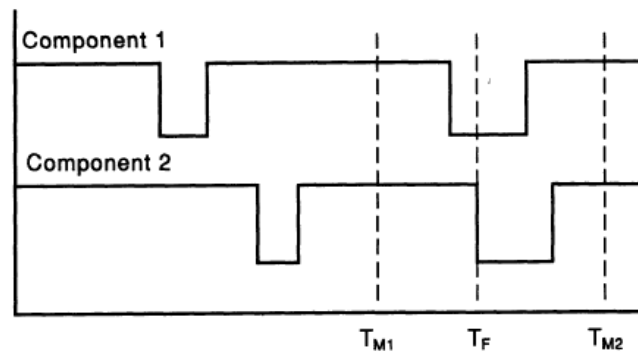

Figure 3-10 Operating cycles of a two-component parallel redundant system

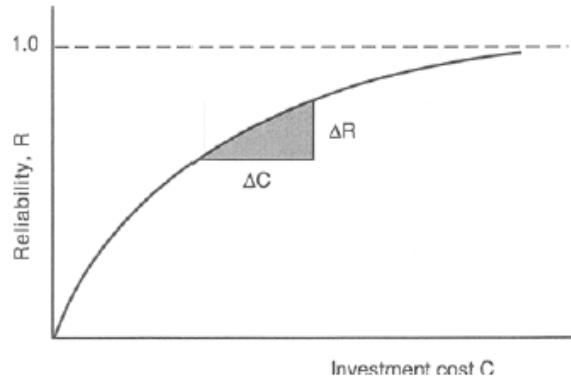

Figure 3-11 Incremental reliability cost

3.5 Reliability Worth Analysis

Reliability worth assessment is used to incorporate cost analysis and quantitative reliability assessment into a common platform for a decision making process. Economics and cost analysis are the most important parts in reliability applications. To raise the level of reliability of a system, investment cost must be increased accordingly. Higher reliability is more expensive. Investment cost is only used for reliability cost analysis. Figure 3.11 illustrates the reliability cost variation. Incremental cost ($\frac{\Delta C}{\Delta R}$) is used for analysis purpose.

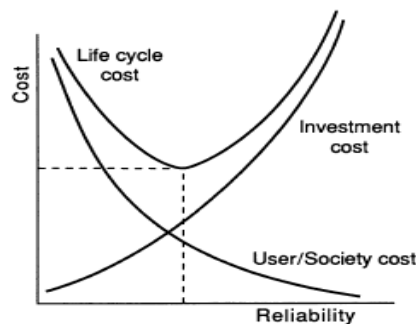

Figure 3-12 Reliability and total system cost

However, customer benefit should be considered for reliability worth analysis. It is so complex and difficult to obtain this accurately. Thus, interruption cost should be quantified for reliability worth analysis. Customer surveys in affected groups are used to evaluate interruption costs which will be discussed in section 3.5.1. In a decision making process, total cost, summation of investment, operating and customer

interruption costs should be compared with reliability, demonstrated in figure 3.12. User/society cost denotes customer interruption cost.

3.5.1 Customer Surveys and Customer Damage Function

There are three categories to evaluate the impact of interruption which are,

- Indirect analytical evaluation
- Case studies of actual blackout
- Customer surveys

The contingent valuation method, the direct costing method and the indirect costing methods are three basic approaches to conduct customer surveys. In contingent valuation method, quantification is done using customer willingness to pay (WTP) or willingness to accept (WTA) the occurrences of an interruption. In the direct costing method, the customer should identify the impacts and evaluate the cost associated with a particular interruption. The valuation of replacements is used to calculate interruption cost of the outage in the indirect costing method.

Customer surveys and case studies can be done only for an existing operating system. Indirect analytical evaluation can be used for a future development in addition to the present operating system. So, an indirect analytical evaluation method was used to evaluate interruption cost of railway system throughout this research.

Customer Damage Functions (CDF) are used to represent the interruption cost. CDF (LKR/kW) was defined using customer surveys in residential, large users, commercial, government, industrial, etc. Sector Customer Damage Function (SCDF) and Composite Customer Damage Function (CCDF) are main two categories which measure the interruption cost of individual sectors and cost of service area or at the distribution bus, respectively.

3.5.2 Reliability Worth Assessment Techniques

Reliability worth assessment techniques are significantly different in each hierarchical level which are HLI, HLII and HLIII. Furthermore, system reliability worth

assessment (Generation, Transmission and Distribution) and system reliability worth assessment for expansion planning techniques are analyzed using different methods.

In this research, system reliability worth assessment was done using assessment techniques in the distribution system. Failure rates and repair time of components and sub-systems were used to define the CCDF. Expected interruption cost was calculated using Expected Energy Not Supplied (EENS) and Interrupted Energy Assessment Rate (IEAR). Detailed assessment will be done in section 5.5.

4. DEVELOPMENT OF THE RELIABILITY EVALUATION MODEL

An integrated, simplified power supply reliability assessment model for a railway network, considering the sub-transmission system was developed. Grid substations (GSS), transmission lines and traction substations (TSS) were integrated into the model to evaluate reliability indices. Transmission lines, grid substations and traction substations are the key sub-systems in the power supply configuration of electrified railways. These three sub-systems can be independently modeled and combined in series to form the final model.

The model commenced at the Grid Substation (GSS). The generation and transmission (G&T) network feeding the GSS was assumed to be 100% reliable. G&T network was assigned the hierarchical level I (HL I). The sub-transmission network comprising GSS, transmission/cable lines and TSS connects the G&T network to the distribution network.

4.1 Grid Substation Modeling

A grid substation is a large installation in the power system for stepping down higher transmission voltage (220kV/132kV) to distribution voltages (33kV/11kV). Line bays, high voltage bus bar (BB), transformer bays and low voltage BB were included in the grid substation model. Fig. 4.1 shows the GSS model.

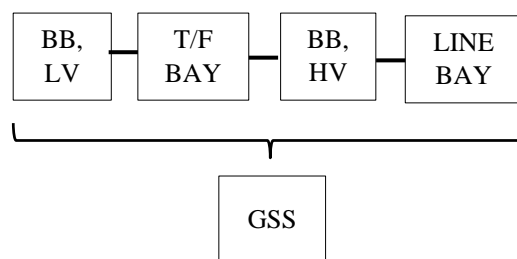

Figure 4-1 GSS reliability model

Repeated application of (1) and (2) lead to failure rate of GSS, λ_{GSS} and MTTR of GSS, r_{GSS} , as given in (10) and (11). The equivalent failure rates of line bay, high voltage BB, transformer bay and low voltage BB are denoted by λ_{LB} , λ_{BBH} , λ_{TB} and λ_{BB} respectively. Similarly, the equivalent MTTR of line bay, high voltage BB,

transformer bay and low voltage BB are denoted by r_{LB} , r_{BBH} , r_{TB} and r_{BBL} , respectively.

$$\lambda_{GSS} = \lambda_{LB} + \lambda_{BBH} + \lambda_{TB} + \lambda_{BBL} \quad (10)$$

$$r_{GSS} = \frac{(\lambda_{LB} \times r_{LB} + \lambda_{BBH} \times r_{BBH} + \lambda_{TB} \times r_{TB} + \lambda_{BBL} \times r_{BBL})}{\lambda_{GSS}} \quad (11)$$

Lightening arrestor (LA), capacitive voltage transformer (CVT), isolator with earth switch (ISO+ES), current transformer (CT), circuit breakers (CB) and isolator (ISO) were connected in series in a single line bay. In addition, the main transformer (TF), neutral current transformer (NCT), earthing transformer (ETF) and auxiliary transformer (ATF) were included in the transformer bay. Using (1), (2), (3) and (4), λ_{LB} and r_{LB} were calculated and displayed in Table 4-1 for a GSS with two parallel line bays. Table 4-2 shows the evaluation procedure of λ_{TB} and r_{TB} with two parallel transformer bays in a GSS.

TABLE 4-1 EVALUATION OF LINE BAY IN GSS

Description		Failure Rate (f/yr)	MTTR (h)
Input	LA	λ_1	r_1
	CVT	λ_2	r_2
	ISO+ES	λ_3	r_3
	CT	λ_4	r_4
	CB	λ_5	r_5
	ISO	λ_6	r_6
Output	Series components of Line Bay	$\lambda_{LB,s} = \sum_{i=1}^6 \lambda_i$	$r_{LB,s} = \frac{\sum_{i=1}^6 r_i \times \lambda_i}{\lambda_{LB,s}}$
	Two parallel lines	$\lambda_{LB} = \frac{(\lambda_{LB,s})^2 \times (r_{LB,s} \times 2)}{8760}$	$r_{LB} = \frac{(r_{LB,s})^2}{(2 \times r_{LB,s})}$

Failure rate of the high voltage BB and the voltage transformer at BB and related MTTR values are denoted by λ_{BBh} , λ_{VT} and r_{BBh} , r_{VT} respectively. After identifying the bus bar configuration and extracting related reliability data [30], λ_{BBH} and r_{BBH} can be calculated using (12) and (13).

$$\lambda_{BBH} = \lambda_{BBh} + \lambda_{VT} \quad (12)$$

$$r_{BBH} = \frac{(r_{BBh} \times \lambda_{BBh}) + (r_{VT} \times \lambda_{VT})}{\lambda_{BBH}} \quad (13)$$

TABLE 4-2 EVALUATION OF TRANSFORMER BAY IN A GSS

Description		Failure Rate (f/yr)	MTTR (h)
Input	<i>ISO</i>	λ_9	r_9
	<i>CB</i>	λ_{10}	r_{10}
	<i>CT</i>	λ_{11}	r_{11}
	<i>LA</i>	λ_{12}	r_{12}
	<i>TF</i>	λ_{13}	r_{13}
	<i>NCT</i>	λ_{14}	r_{14}
	<i>ETF+NCT</i>	λ_{15}	r_{15}
	<i>ATF</i>	λ_{16}	r_{16}
	<i>VT</i>	λ_{17}	r_{17}
	<i>CT</i>	λ_{18}	r_{18}
	<i>CB</i>	λ_{19}	r_{19}
	<i>ISO+ES</i>	λ_{20}	r_{20}
Output	Series components of transformer bay	$\lambda_{TB,s} = \sum_{i=9}^{20} \lambda_i$	$r_{TB,s} = \frac{\sum_{i=9}^{20} r_i \times \lambda_i}{\lambda_{TB,s}}$
	Two parallel lines	$\lambda_{TB} = \frac{(\lambda_{TB,s})^2 \times (r_{TB,s} \times 2)}{8760}$	$r_{TB} = \frac{(r_{TB,s})^2}{(2 \times r_{TB,s})}$

Similarly, the failure rate and MTTR of the low voltage BB λ_{BBL} and r_{BBL} can be calculated.

4.2 Sub-Transmission System Modeling

Reliability of transmission line/cable line from GSS to TSS can be modeled as a series combination as shown in Figure 4.2. Table 4-3 illustrates the evaluation procedure of the equivalent failure rate λ_{TXL} and MTTR r_{TXL} of two feeder bays and transmission/cable lines.

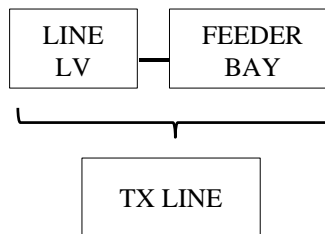

Figure 4-2 Transmission line reliability model

TABLE 4-3 EVALUATION OF THE TRANSMISSION LINE

Description		Failure Rate (f/yr)	MTTR (h)
Input	ISO	λ_{23}	r_{23}
	CB	λ_{24}	r_{24}
	CT	λ_{25}	r_{25}
	ISO+ES	λ_{26}	r_{26}
	VT	λ_{27}	r_{27}
	LA	λ_{28}	r_{28}
	LINE	λ_L	r_L
Output	Series components of feeder bay and transmission line	$\lambda_{FB,s} = \sum_{i=23}^{28} \lambda_i + \lambda_L$	$r_{FB,s} = \frac{\sum_{i=23}^{28} r_i \times \lambda_i + r_L \lambda_L}{\lambda_F}$
	Two parallel lines	$\lambda_{TXL} = \frac{(\lambda_{FB,s})^2 \times (r_{FB,s} \times 2)}{8760}$	$r_{TXL} = \frac{(r_{FB,s})^2}{(2 \times r_{FB,s})}$

4.3 Traction Substation Modelling

The traction substation which steps down the high voltage to 25kV single phase is the most important part of an electrified railway system, to feed the high-speed locomotives through the catenary. TSS was designed to minimize the voltage unbalance, voltage flickers and harmonics caused by the single phase, non-sinusoidal train loads [17]. Figure 4.3 shows the single line arrangement of a TSS comprising two transformer bays, a single bus bar arrangement and four feeder bays [3, 29]. A short description of symbols used in Figure 4.3 are given in Table 4-4. Transformers were sized in such a way that any one of them can deliver the full traction load in case of a forced outage of the other.

Figure 4.4 shows the reliability model of a TSS with feeding lines to the railway network. This model was used to evaluate reliability up to the connection point of the catenary. Table 4-4 illustrates the evaluation procedure of the equivalent failure rate λ_{TSS} and MTTR r_{TSS} of the TSS with the overhead/cable line connecting the TSS to the catenary. The failure rate $\lambda_{TBT,s}$ and MTTR $r_{TBT,s}$ of the series combination of transformer bay, BB and two parallel lines were calculated using (14) and (15).

$$\lambda_{TBT,s} = \sum_{31}^{43} \lambda_i + \lambda_{BBT} + \lambda_{TXLT} \quad (14)$$

$$r_{TBT,s} = \frac{\sum_{31}^{43} r_i \lambda_i + r_{LT} \lambda_{LT} + r_{TXLT} \lambda_{TXLT}}{\lambda_{TBT,s}} \quad (15)$$

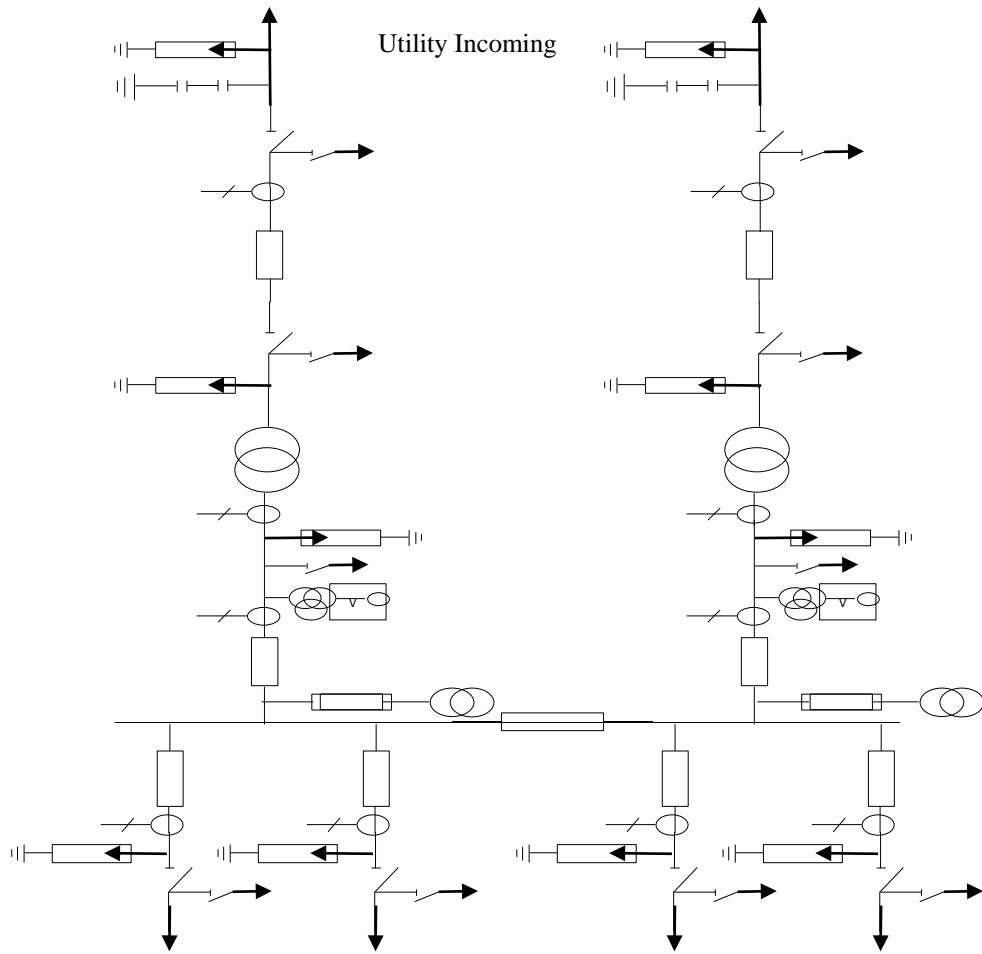

Figure 4-3 Single line diagram of a TSS

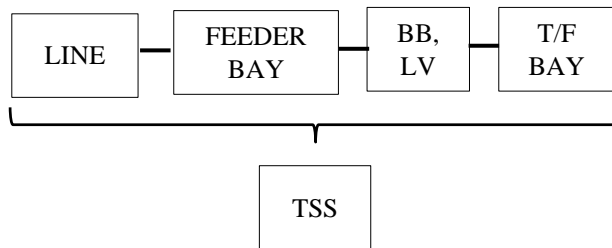

Figure 4-4 TSS reliability model

TABLE 4-4 SYMBOLS OF SLD IN TSS

Description	Symbol
ISO	
CB	
CT	
ISO+ES	
CVT	
LA	
TF	
ES	
ATF	

TABLE 4-5 EVALUATION OF TSS

Description		Failure Rate (f/yr)	MTTR (h)
Input	CB	λ_{44}	r44
	CT	λ_{15}	r45
	LA	λ_{46}	r46
	ISO+ES	λ_{47}	r47
	LINE	λ_{LT}	rLT
Output	Series components of feeder bay and transmission line	$\lambda_{FBT,s} = \sum_{i=44}^{47} \lambda_i + \lambda_{LT}$	$r_{FBT,s} = \frac{\sum_{i=44}^{47} r_i \times \lambda_i + r_{LT} \lambda_{LT}}{\lambda_{FBT,s}}$
	Two parallel lines	$\lambda_{TXLT} = \frac{(\lambda_{FBT,s})^2 \times (r_{FBT,s} \times 2)}{8760}$	$r_{TXLT} = \frac{(r_{FBT,s})^2}{(2 \times r_{FBT,s})}$
Input	LA	λ_{31}	r31
	ISO+ES	λ_{32}	r32
	CT	λ_{33}	r33
	CB	λ_{34}	r34
	ISO+ES	λ_{35}	r35
	LA	λ_{36}	r36
	TF	λ_{37}	r37
	NCT	λ_{38}	r38
	LA	λ_{39}	r39
	ES	λ_{40}	r40
	VT	λ_{41}	r41
	CB	λ_{42}	r42
	ATF	λ_{43}	r43
BB	λ_{BBT}	rBBT	
Output	Series components of Transformer Bay	$\lambda_{TBT,s}$	$r_{TBT,s}$
	Two parallel lines	$\lambda_{TSS} = \frac{(\lambda_{TBT,s})^2 \times (r_{TBT,s} \times 2)}{8760}$	$r_{TSS} = \frac{(r_{TBT,s})^2}{(2 \times r_{TBT,s})}$

4.4 Establishment of an Integrated Reliability Assessment Model

An integrated power supply reliability model was established as shown in figure 4-5 to evaluate the reliability of each configuration to supply power to the railway network. Reliability indices of each configuration namely the failure rate and MTTR of the integrated system were calculated using (16) and (17). Those indices are expected to be different for each configuration due to differences in GSS configuration, transmission line/cable line network. Reliability indices of TSS would also depend on line parameters and line lengths.

$$\lambda = \lambda_{GSS} + \lambda_{TXL} + \lambda_{TSS} \quad (16)$$

$$r = \frac{r_{GSS}\lambda_{GSS} + r_{TXL}\lambda_{TXL} + r_{TSS}\lambda_{TSS}}{\lambda} \quad (17)$$

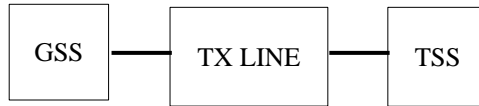

Figure 4-5 Integrated power supply reliability model

Other reliability parameters such as the annual interruption duration, availability and reliability of each power supply configuration were calculated using (7), (8) and (9). Based on these reliability parameters, the best network configuration can be selected.

The relatively complex models discussed above are capable of providing accurate reliability indices to assist the decision-making process. Further, a simplified model was also developed to facilitate more convenient comparison of different configurations.

4.5 Simplified Reliability Assessment Model

Model simplification was done in the GSS, transmission/cable line and the TSS reliability models, for convenience in calculations, making certain assumptions and using statistical reliability data [30].

The system was considered to be a partially redundant system, operated with all equipment in service until a forced outage occurs. Throughout the simplified model,

the failure rate and MTTR of all cable lines were assumed to be direct buried lines and transmission lines were taken as aerial cables. Failure rates of VT, CT, NCT, LA, ATF, and ETF were assumed to be negligible as they did not anyway contribute significantly to the end-result. The failure rates and MTTR of all CB, ISO/ISO+ES, TF, BB and lines were fully considered in the simplified model. Further, the failure rates and MTTR of all CB and ISO in the same GSS/TSS were assumed to be identical.

TABLE 4-6 EVALUATION OF A GSS

Description		Failure Rate (f/yr)	MTTR (h)
Input	<i>ISO</i>	λ_{iso}	r_{iso}
	<i>CB</i>	λ_{cb}	r_{cb}
	<i>TF</i>	λ_{tf}	r_{tf}
	<i>CB</i>	λ_{cb}	r_{cb}
	<i>ISO+ES</i>	λ_{iso}	r_{iso}
Output	Series components of transformer bay	$\lambda_{TB,s}$	$r_{TB,s}$
	Two parallel lines	$\lambda_{TB} = \frac{(\lambda_{LB,s})^2 \times (r_{LB,s} \times 2)}{8760}$	$r_{TB} = \frac{(r_{LB,s})^2}{(2 \times r_{LB,s})}$

Table 4-6 demonstrates the simplified evaluation procedure of the GSS. Thus, the failure rate and MTTR of the GSS were calculated using (18) and (19).

$$\lambda_{TB,S} = 2 \times \lambda_{iso} + 2 \times \lambda_{cb} + \lambda_{tf} \quad (18)$$

$$r_{TB,S} = \frac{2 \times r_{iso} \lambda_{iso} + 2 \times r_{cb} \lambda_{cb} + r_{tf} \lambda_{tf}}{\lambda_{TB,S}} \quad (19)$$

Similarly, the models of transmission line and TSS were simplified and the values $\lambda_{TBT,s}$, $\lambda_{FB,s}$, $\lambda_{LB,s}$, $r_{TBT,s}$, $r_{FB,s}$ and $r_{LB,s}$ were calculated using the simplified models.

Final reliability indices of a power supply configuration were thus estimated using (16) and (17). Figure 4-6 shows the simplified reliability diagram of CSRN feeding options.

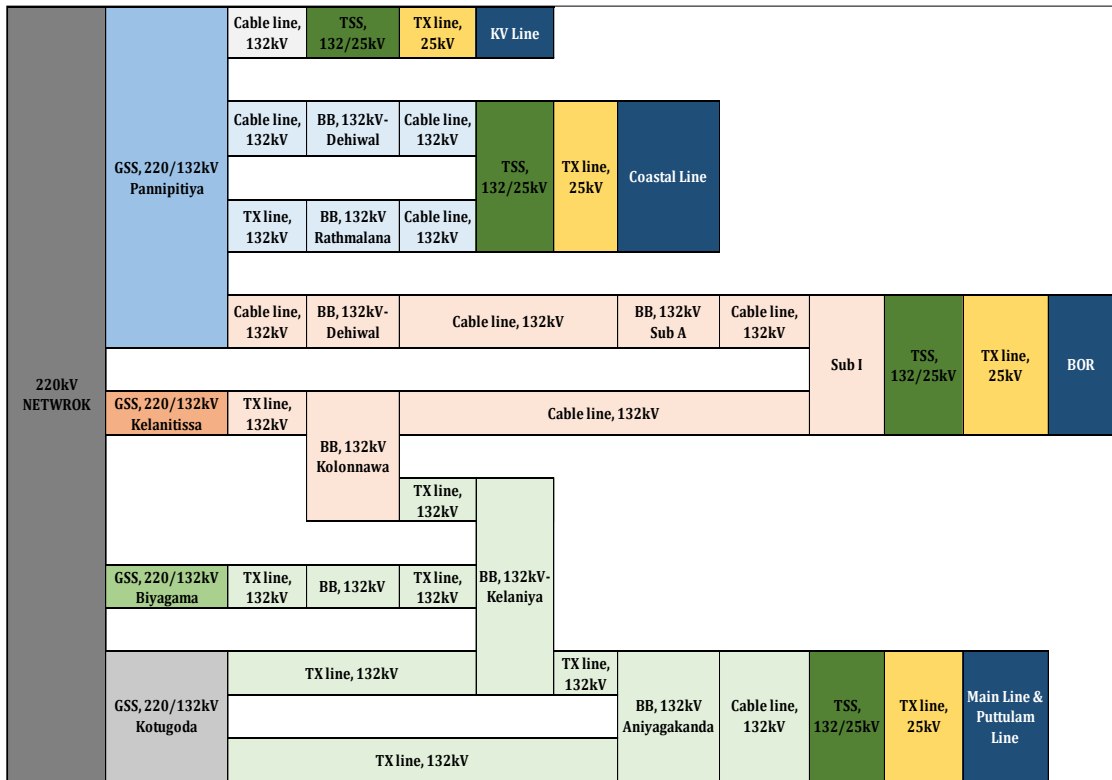

Figure 4-6 Simplified reliability diagram of CSRN feeding options

5. ASSESSMENT OF RELIABILITY INDICES AND WORTH ANALYSIS

The models described above were used to assess the power supply reliability of the proposed Colombo Suburban Railway Network (CSRN) in Sri Lanka. The assessment model was validated by calculating reliability indices in eight different scenarios and comparing the result against simulation results obtained from the Monte Carlo simulation. Eight different scenarios from coastal, Kelani Valley (KV), main and Puttalam lines in CSRN were considered in the case study.

5.1 Reliability Data and IEEE Standards

TABLE 5-1 RELIABILITY DATA

Reference	Equipment	Equipment Subclass	Failure Rate, λ (f/yr)	MTTR, r(h/f)	Remarks
IEEE Gold	Cables	Above 15kV	0.011024	16	
		600V-15kV	0.020243	35	
	All aerial cables		1.000261	2.29	Per 1km
	All direct buried cables		1.000689	6.03	Per 1km
	Circuit breakers	Above 600V	0.003600	168	
	Switchgear busses	Above 600V	0.001917	36	
	Transformers	Liquid Filled	0.015300	1178.5	
IEEE Standard (493-1997)	MV conductors		0.00613	97	per 1000 ft, buried conduit
	MV CB		0.00360	2.1	Replace CB
	Transformer		0.00300	130	Replace
	Switchgear bus		0.01020	26.8	
	MV switch		0.00610	3.6	
	Synch bus		0.0102	26.8	
	Double bus		0.008573	10.56	
IEEE Gold	LV transformer		0.00300	130	Replace
	LV CB		0.00270	4	Replace CB
	Switchgear bus		0.00170	24	
	LV conductors (Direct burial)		0.00388	24	per 1000ft
	LV switch		0.00610	3.6	

Substantial research to estimate reliability data power system components such as circuit breakers, transformers, transmission cables, and isolators have been reported. Those values differ from each other due to various external factors such as weather, ambient temperature, preventive maintenance done, operating conditions, etc. Therefore, accuracy of reliability assessment depends on reliability data of components. Therefore, standard reliability data were used for this evaluation. As a result, reliability indices may be varied from the actuals values but are very effectively usable for comparisons.

All reliability data used for the assessment of reliability indices was used from IEEE Gold Book/IEEE Standard (493-1997). Table 5-1 shows the reliability data used.

5.2 Transmission Network for CSRP Feeding Options

Schematic diagrams of power supply feeding option to feed CSRN were prepared for the reliability evaluation. These diagrams were prepared using the 2017 transmission system proposed by CEB [26]. Figure 5-1 shows the equivalent sub-transmission network of the power supply configuration for coastal line and KV line. Figure 5-2 illustrates same information for the main line & the Puttalam line. Schematic diagrams of CSRP feeding configurations are provided in ANNEX-F.

The G&T network was considered to be the 220kV transmission network and generation plants. Pannipitya, Kotugoda, Kelanitissa and Biyama are GSS with 220kV high voltage bus bars, 132kV bus bars with 250MVA transformers. There are two 250 MVA transformers each in Pannipitiya, Kotugoda & Biyagama and two 150MVA transformers each in Kelanitissa. Dehiwala, Ratmalana, Sapugaskanda, Kolonnawa, Kelaniya and Aniyakanda are GSS with 132kV bus bars. C1 and C2 were proposed 132kV cable lines with feeder bay and line bay of T1. TX1 and TX2 are proposed 132kV transmission lines with feeder bays and line bays of T2 and T3, respectively. L1, L2 and L3 will be 132kV transmission lines with feeder bay connected directly to catenary of the coastal, KV and main & Puttalam lines, respectively. T1, T2 and T3 will be traction substations with two traction transformers each, to feed coastal, KV line and main & Puttalam lines, respectively.

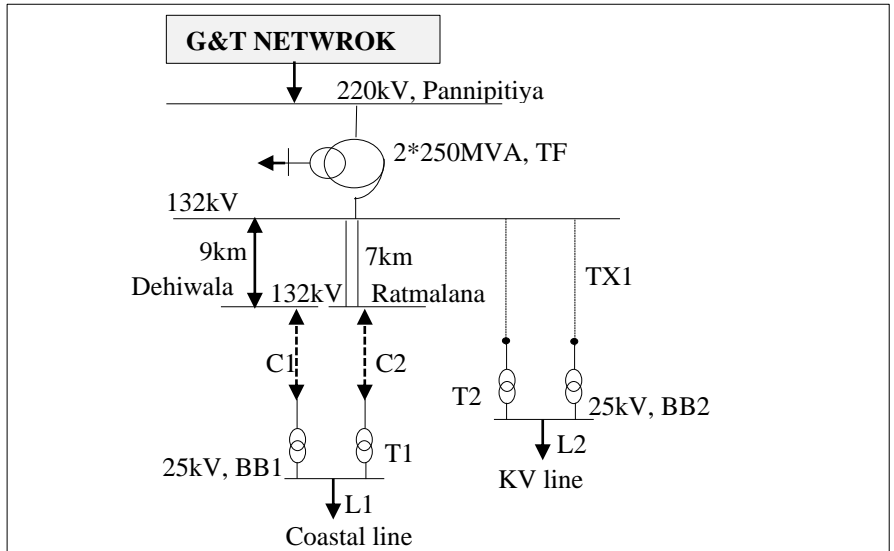

Figure 5-1 Equivalent power supply configuration for coastal and KV lines

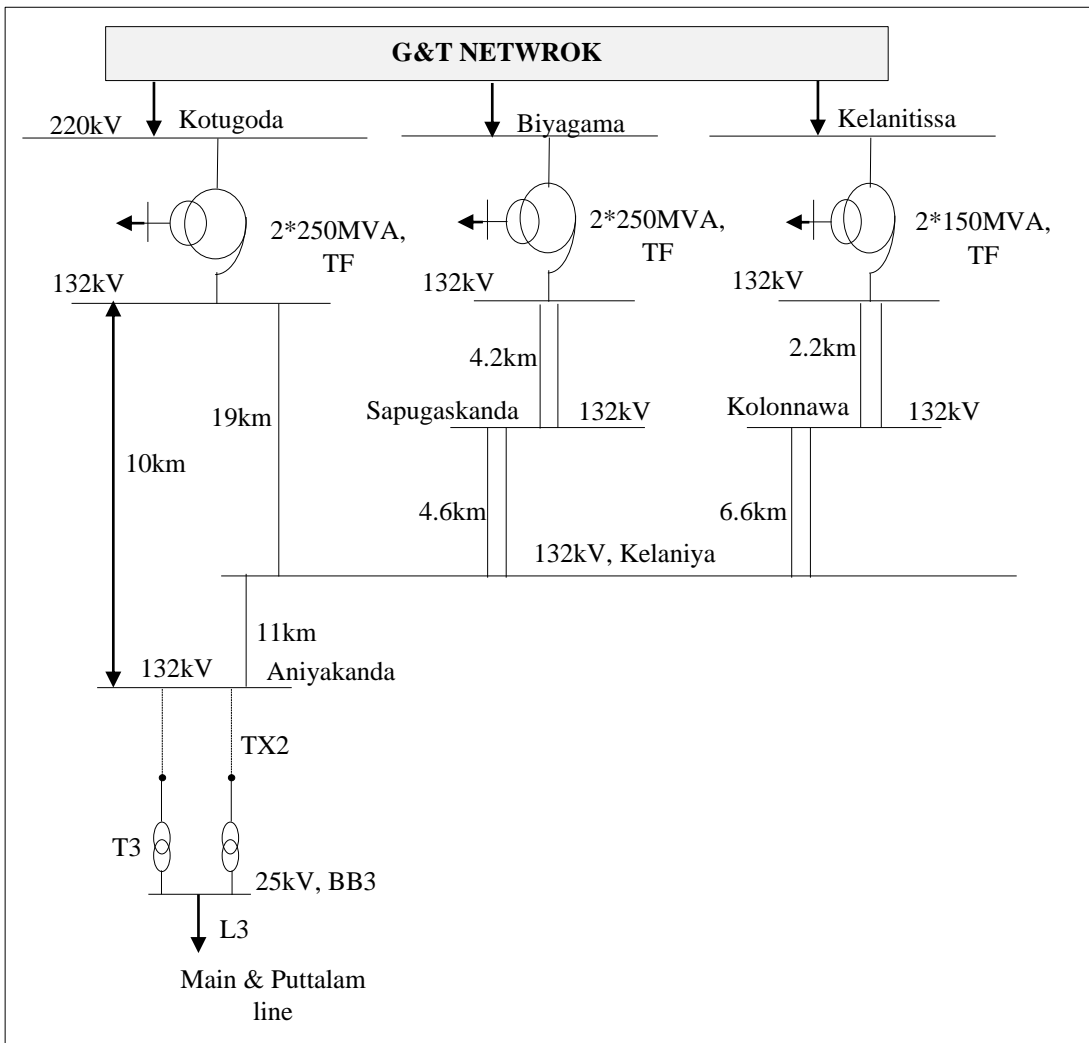

Figure 5-2 Equivalent power supply configuration of main & Puttalam lines

5.3 Reliability Block Diagram of CSRN Feeding Options

Reliability block diagram is a diagrammatic representation of components which are connected in the complex system or network. This block diagram illustrates the reliability analysis structure by including series, parallel, standby or other arrangements of components in the system. Reliability block diagram can be used to identify possibilities for reliability improvements, too.

The reliability block diagram in figure 5-3 was developed using the schematic diagram and selected feeding options for CSRN. BOR was also included for in this block diagram to identify the most reliable feeding option through the reliability assessment. The diagram displays only one feeding option of each railway line in CSRN.

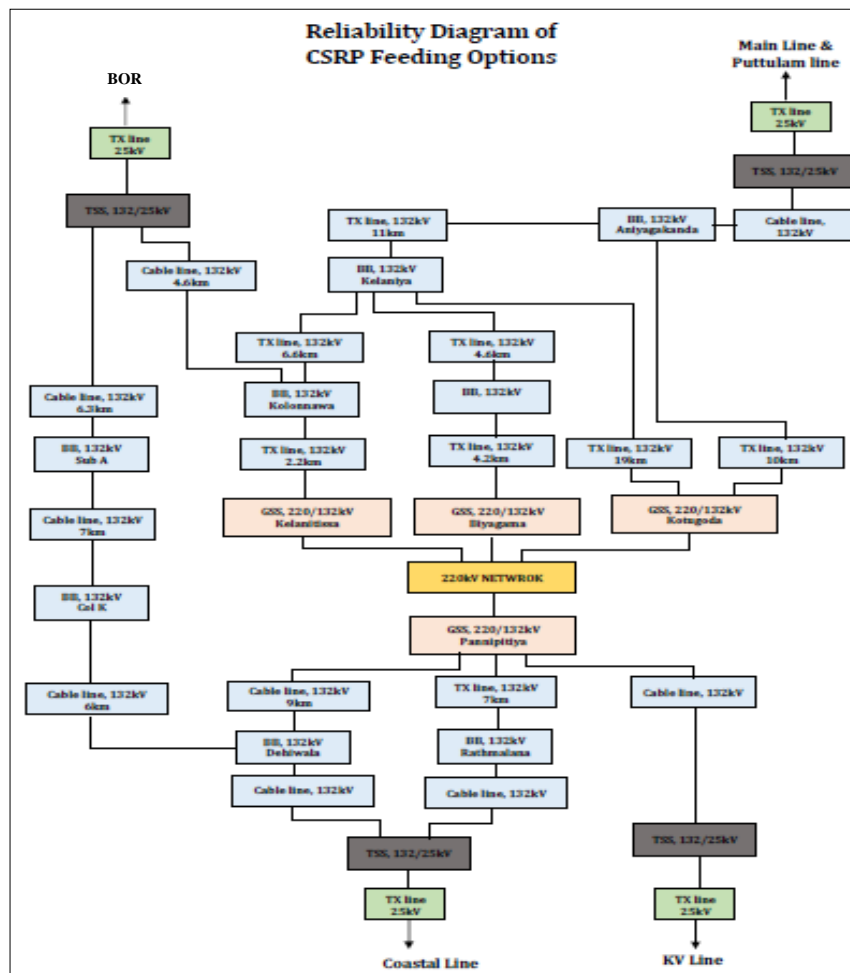

Figure 5-3 Reliability Diagram of CSRN feeding options

5.4 Assessment of Reliability Indices

Reliability indices of power supply configuration to coastal, KV and main & Puttalam lines were calculated using the simplified, integrated reliability assessment model developed in this research. Failure rate and MTTR of eight optional configurations for the supply of power to all lines in CSRN were evaluated. The annual interruption duration and the reliability of each configurations was calculated using (7) and (9). Table 5-2 briefly illustrates the eight options.

TABLE 5-2 POWER SUPPLY FEEDING OPTIONS IN CSRP

Railway Line	Power supply options	
KV Line	1	TSS is located at Pannipitiya GSS
	2	TSS is located near the railway track
Coastal Line	3	Feed TSS from Ratmalana and Dehiwala GSS
	4	Feed TSS only from Ratmalana GSS
	5	Feed TSS only from Dehiwala GSS
Main Line & Puttalam Line	6	Feed TSS using existing network
	7	Line in and out connection from Kotugoda - Kelaniya line
	8	Locate the TSS at Wanawasala and feed TSS from Kelaniya GSS

5.4.1 Reliability Assessment of CSRP feedings Options using Analytical Method

5.4.1.1 Options to Feed the KV Line

In option one, only T2 and extended L2 (TSS is located at Pannipitiya GSS) would supply power. Figure 5-1 shows equivalent power supply configurations for coastal and KV lines.

Table 5-3 and 5-4 show calculated reliability indices of option one and two, respectively, using the model developed. Table 5-5 shows comparison of results, interruption duration and reliability between option one and two. Detailed reliability indices evaluated for KV line is provided in ANNEX H.

TABLE 5-3 RELIABILITY INDICES OF OPTION 1

Description	OPTION 1			
	<i>GSS</i>	<i>TX LINE</i>	<i>TSS</i>	<i>KV line</i>
Failure rate (f/h)	0.01715	0.000000186	0.000003445	0.01715
MTTR(h)	10.56	1.16	8.79	10.56

TABLE 5-4 RELIABILITY INDICES OF OPTION 2

Description	OPTION 2			
	<i>GSS</i>	<i>TX LINE</i>	<i>TSS</i>	<i>KV line</i>
Failure rate (f/h)	0.01715	0.001413	0.000003445	0.01856
MTTR(h)	10.56	3.00	8.79	9.98

TABLE 5-5 COMPARISON OF RELIABILITY INDICES OF KV LINE

Description	KV LINE	
	<i>Interruption Duration (min/yr)</i>	<i>Reliability</i>
Option 1	10.86	0.982994
Option 2	11.12	0.981606

The following requirements should be fulfilled for each option.

- Option one - TSS is located at Pannipitiya GSS
 - Augmentation of Pannipitiya GSS (2×132kV feeder bays as 2×132kV SB TF bay of TSS, 2×20MVA 132/25kV TF, 2× 25kV TF bay, 4×25kV feeder bays and 1×33kV bus section bay)
 - Construct 4×25kV cable line (900m)
- Option two - TSS is located near the railway track
 - Augmentation of Pannipitiya GSS (2×132kV feeder bays)
 - Construct 2×132kV cable line (900m)
 - Construct new 132/25kV TSS at near to railway line (2×20MVA 132/25kV TF, 2×132kV SB TF bay, 2× 25kV TF bay, 4×25kV feeder bays and 1×33kV bus section bay)

5.4.1.2 Options to Feed the Coastal Line

In option three, power was supplied through C1, C2, T1 and L1 (Feed TSS from Ratmalana and Dehiwala GSS). In option four, power feeding arrangement was through C2, T1 and L2 only without using C1 (Feed TSS only using Ratmalana GSS). C2 cable line was a double circuit in option four. In option five, C1, T1 and L1 were used to supply power (Feed TSS only using Dehiwala GSS). However, C1 cable line was a double circuit only in option five. Table 5-6, table 5-7 and table 5-8 show calculated reliability indices of option three, four and five, respectively. Annual interruption

duration and the reliability of the power supply configuration were calculated using (7) and (9). Table 5-9 shows comparison of reliability indices.

TABLE 5-6 RELIABILITY INDICES OF OPTION THREE

Description	OPTION 3			
	GSS	TX LINE	TSS	Coastal line
Failure rate (f/h)	0.01715	0.010119	0.000003445	0.02727
MTTR(h)	10.56	7.78	8.79	9.53

TABLE 5-7 RELIABILITY INDICES OF OPTION FOUR

Description	OPTION 4			
	GSS	TX LINE	TSS	Coastal line
Failure rate (f/h)	0.01715	0.01456	0.000003445	0.03170
MTTR(h)	10.56	8.98	8.79	9.84

TABLE 5-8 RELIABILITY INDICES OF OPTIO FIVE

Description	OPTION 5			
	GSS	TX LINE	TSS	Coastal line
Failure rate (f/h)	0.01715	0.02311	0.000003445	0.04027
MTTR(h)	10.56	22.5	8.79	17.41

TABLE 5-9 RELIABILITY INDICES COMPARISON OF COASTAL LINE

Description	COASTAL LINE	
	Interruption Duration (min/yr)	Reliability
Option 3	15.59	0.973096
Option 4	18.71	0.968789
Option 5	42.07	0.960533

Simplified equivalent power supply configuration was shown in figure 5-1. Figure 5-2 can be referred for a clear understanding power supply configuration. Detailed evaluation of reliability indices of the coastal line is provided in ANNEX I.

Following requirements should be fulfilled to feed power to the coastal line in option three, four and five, respectively.

- Option three - Feed from Ratmalana and Dehiwala GSS
 - Construct new 132/25kV TSS near the railway track (2×25MVA 132/25kV TF, 2×132kV SB TF bay, 2×25kV TF bay, 4×25kV feeder bays and 1×33kV bus section bay) – T1
 - Construct 132kV cable line Ratmalana to TSS(1.6km) – C2
 - Construct 132kV cable line Dehiwala to TSS(1.7km) – C1
- Option four - Feed TSS only using Ratmalana GSS
 - Construct new 132/25kV TSS near the railway track (2×25MVA 132/25kV TF, 2×132kV SB TF bay, 2×25kV TF bay, 4×25kV feeder bays and 1×33kV bus section bay) –T1
 - Construct 2×132kV cable line Ratmalana to TSS(1.6km) – C2
- Option five - Feed TSS only using Dehiwala GSS
 - Construct new 132/25kV TSS near the railway track (2×25MVA 132/25kV TF, 2×132kV SB TF bay, 2×25kV TF bay, 4×25kV feeder bays and 1×33kV bus section bay) –T1
 - Construct 2×132kV cable line Dehiwala to TSS(1.7km) – C1

5.4.1.3 Options to Feed the Main and Puttalam Lines

In option six (Feed TSS using existing network), TX2, T3 and L3 were used to feed power through Aniyakanda GSS. Figure 5-2 shows the equivalent power supply configuration of main and Puttalam lines. As an alternative solution, line in and out connection from Kotugoda - Kelaniya line (132kV transmission line) was proposed to feed T1, as option seven. In option eight, Kelaniya GSS was used to feed TSS located at Wanalasala. But, this option was reviewed though the final feasibility study report for KV line [3]. However, reliability evaluation was done for this option too.

Following requirements should be fulfilled for option six, seven and eight.

- Option six - Feed TSS using the existing network

- Construct new 132/25kV TSS near the railway track (2×25MVA 132/25kV TF, 2×132kV SB TF bay, 2×25kV TF bay, 4×25kV feeder bays and 1×33kV bus section bay) – T3
- Construct Zebra, 132kV, double circuit transmission line, Aniyakanda to TSS (2.8km) – TX2
- Augmentation of Aniyakanda GSS (2×132kV feeder bays)
- Option seven - Line in and out connection from Kotugoda - Kelaniya line
 - Construct new 132/25kV TSS near the railway track (2×25MVA 132/25kV TF, 2×132kV SB TF bay, 2×25kV TF bay, 4×25kV feeder bays and 1×33kV bus section bay) –T3
 - Construct 2×132kV SB TL bays, 132kV SB arrangement including a bus section at TSS
 - Single line in and out connection from Kotugoda - Kelaniya Line
 - Construct Zebra, 132kV, double circuit transmission line (2km)
- Option eight - Locate the TSS at Wanawasala and feed TSS from Kelaniya GSS
 - Construct new 132/25kV TSS near the railway track (2×25MVA 132/25kV TF, 2×132kV SB TF bay, 2×25kV TF bay, 4×25kV feeder bays and 1×33kV bus section bay) –T3
 - Construct 132kV cable line Kelaniya to TSS (1.9km)
 - Augmentation of Kelaniya GSS (2×132kV feeder bays)

Table 5-10, 5-11 and 5-12 show calculated reliability indices of option six, seven and eight, respectively. Annual interruption duration and reliability of option six, seven and eight are compared in Table 5-13. Detailed calculation is provided in ANNEX J.

TABLE 5-10 RELIABILITY INDICES OF OPTION SIX

Description	OPTION 6		
	GSS & TX LINE	TSS	Main & Puttalam lines
Failure rate (f/h)	0.02443	0.000003445	0.024438
MTTR(h)	17.44	8.789	17.44

TABLE 5-11 RELIABILITY INDICES OF OPTION SEVEN

Description	OPTION 7		
	GSS & TX LINE	TSS	Main & Puttalam lines
Failure rate (f/h)	0.01643	0.000003445	0.016433
MTTR(h)	21.51	8.789	21.51

TABLE 5-12 RELIABILITY INDICES OF OPTION EIGHT

Description	OPTION 8		
	GSS & TX LINE	TSS	Main & Puttalam lines
Failure rate (f/h)	0.01124	0.000003445	0.01125
MTTR(h)	9.39	8.78	9.40

TABLE 5-13 RELIABILITY INDICES COMPARISON OF MAIN & PUTTALAM LINE

Description	MIAN & PUTTALAM LINE	
	<i>Interruption Duration (min/yr)</i>	<i>Reliability</i>
Option 6	25.57	0.975857
Option 7	21.21	0.983701
Option 8	6.34	0.988812

Table 5-14 show the summarized reliability indices evaluation for all options for KV line, coastal line and main & Puttalam line.

TABLE 5-14 SUMMARY OF RELIABILITY INDICES EVALUATION OF ALL OPTIONS

Railway lines	Options	Description	Availability	Interruption Duration (min/yr)	Reliability
KV Line	1	TSS is located at Pannipitiya GSS	0.999979	10.86	0.982994
	2	TSS is located near the railway track	0.999979	11.12	0.981606
Coastal Line	3	Feed TSS from Ratmalana and Dehiwala GSS	0.999970	15.59	0.973097

	4	Feed TSS only from Ratmalana GSS	0.999964	18.71	0.968789
	5	Feed TSS only from Dehiwala GSS	0.999919	42.07	0.960533
Main & Puttalam lines	6	Feed TSS using existing network	0.999239	25.57	0.975858
	7	Line in and out connection from Kotugoda - Kelaniya line	0.999960	21.21	0.983701
	8	Locate the TSS at Wanawasala and feed TSS from Kelaniya GSS	0.999988	6.34	0.988812

5.5.2 Monte Carlo Simulation

The assessment model was validated by comparing, calculated reliability indices of each options with simulation results obtained from the Monte Carlo simulation.

In CSRN study, reliability of a repairable system was considered for simulation. The most reliable options in KV, coastal and main & Puttalam lines (option one, thee and seven) were selected for simulation and comparison. Rejected options were not considered for the simulation study.

For this simulation, fifty thousand random numbers were generated within one and zero. Then, those numbers were converted into operating time using a conversion method. To deduce the system reliability, the sequence of working - repair cycles of each component were simulated and compared. Table 5-15 shows simulation results of options one, thee and seven with different number of simulations. The convergence shows in figure 5-5, 5-6 and 5-7 confirms that selected number of trials (here 50,000) was adequate. Total simulation results of option one, three and seven are provided in ANNEX K.

Figure 5-4, 5-5 and 5-6 show results of option one, three and seven for the comparison between analytical and simulation results. The difference between MCS and analytical model results were 0.000486, 0.000883 and 0.000299, respectively. When the number of simulation attempts were doubled, this difference will further narrow down.

TABLE 5-15 MCS SIMULATION RESULT

Number of simulations	Reliability _ MCS		
	<i>Option 1</i>	<i>Option 3</i>	<i>Option 7</i>
1000	0.981188	0.983168	0.988000
10000	0.983317	0.983117	0.983100
20000	0.982559	0.983558	0.983950
30000	0.983072	0.983480	0.984167
40000	0.983279	0.983480	0.984300
50000	0.983020	0.983480	0.984000

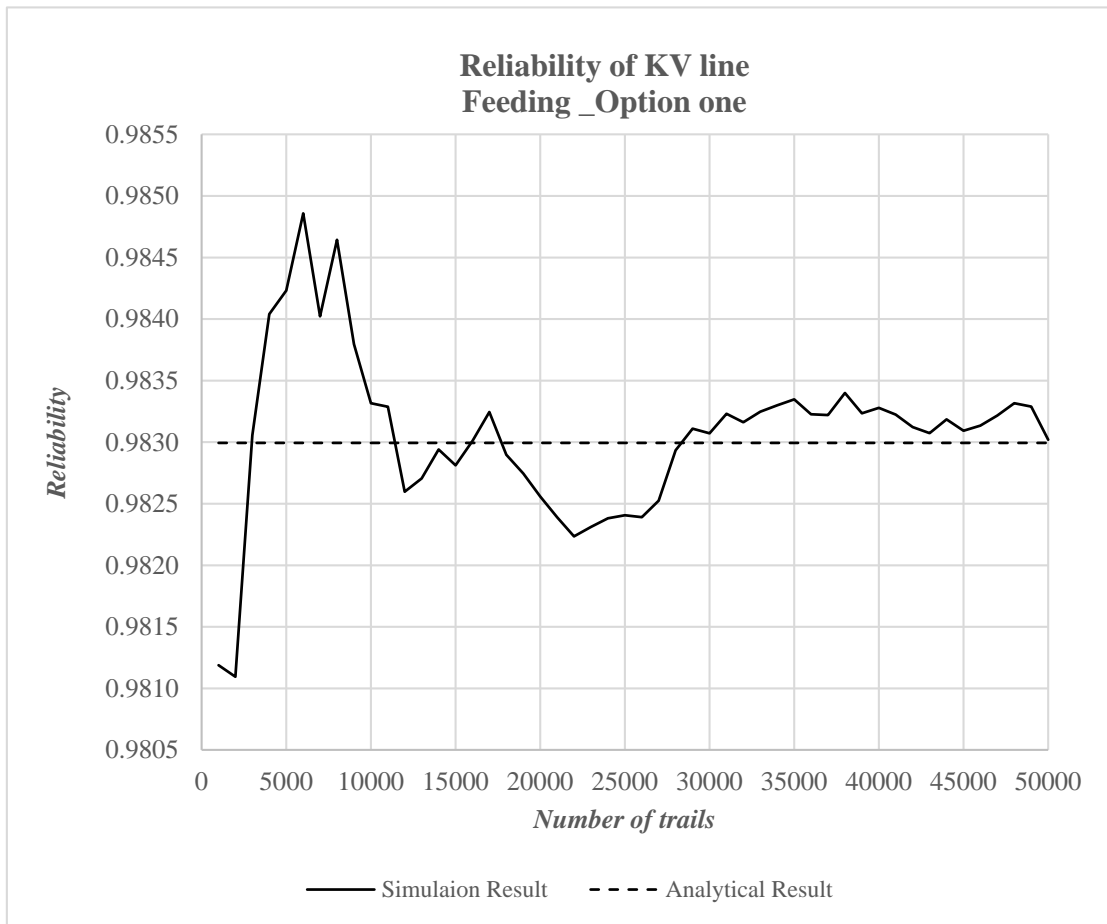

Figure 5-4 Reliability result of option one

Summary of analytical and simulation reliability indices of options one, three and seven are shown in table 5-16

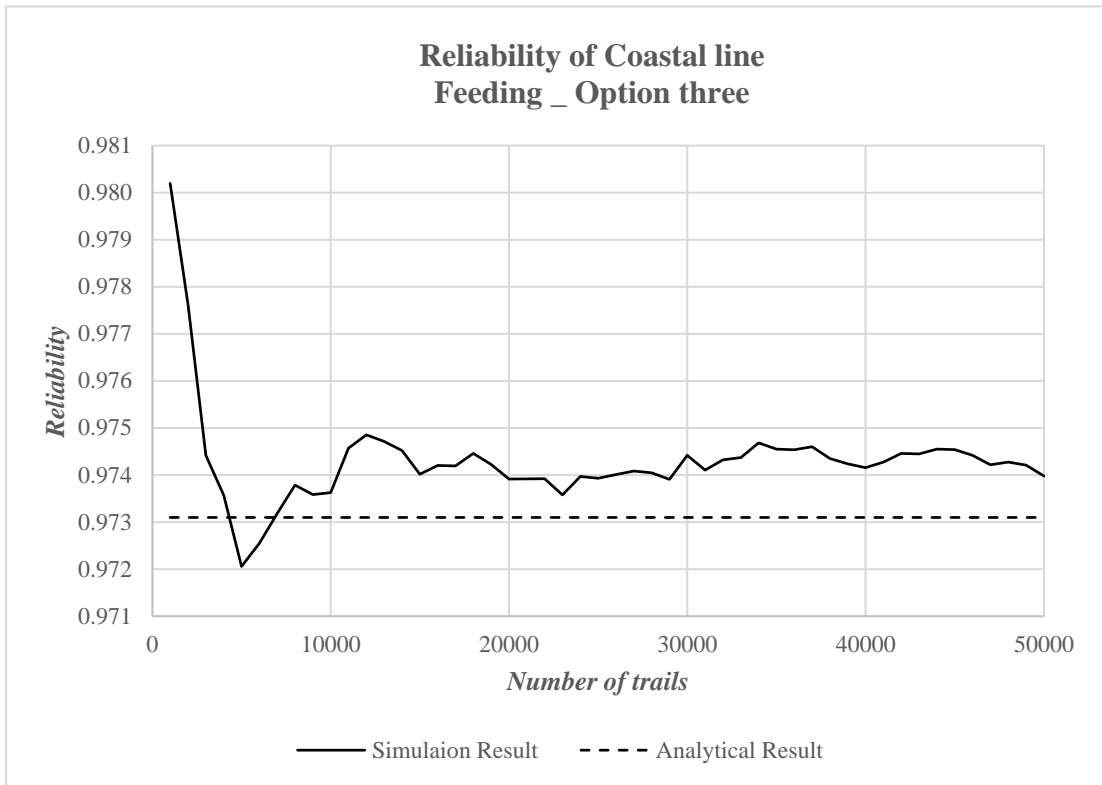

Figure 5-5 Reliability result of option three

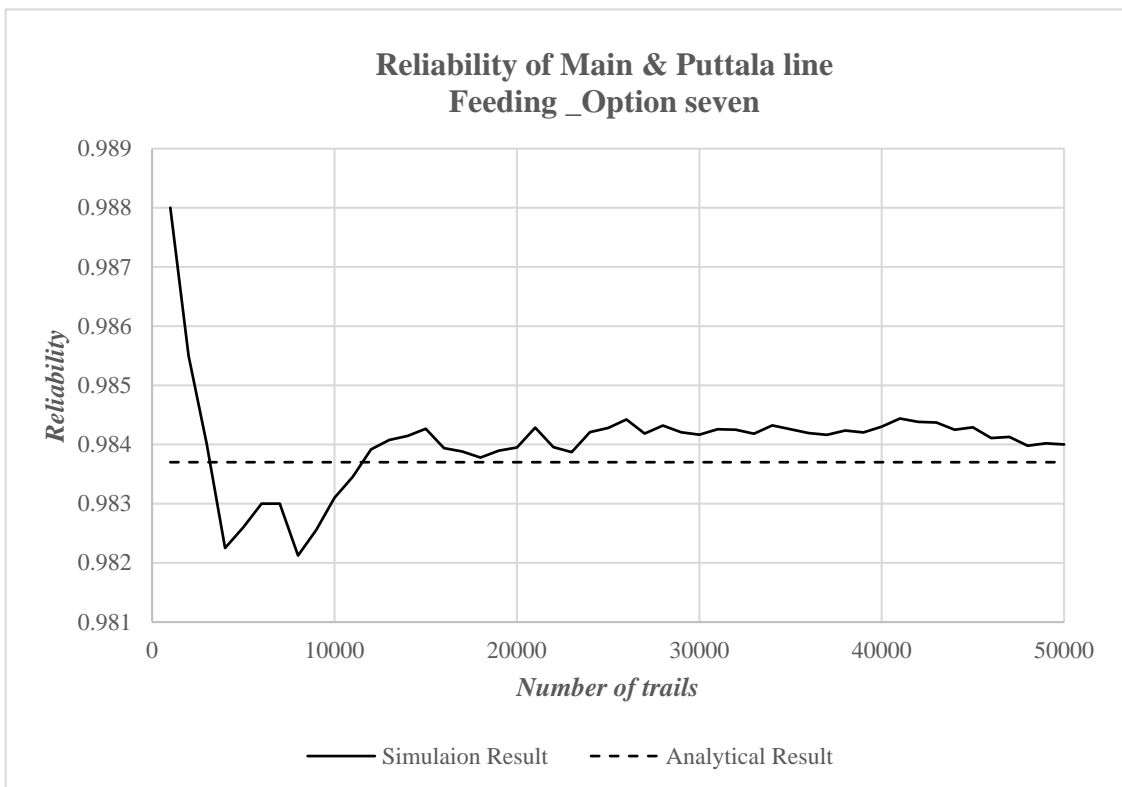

Figure 5-6 Reliability results of option seven

TABLE 5-16 SUMMARY OF EVALUATION OF RELIABILITY INDICES

Description	Availability	Interruption Duration (min/yr)	Reliability using developed model	Reliability using Monte Carlo Simulation
KV Line	0.999979	10.86	0.982994	0.983020
Coastal Line	0.999970	15.59	0.973097	0.983480
Main Line & Puttalam Line	0.999960	21.21	0.983701	0.984000

5.5 Reliability Worth Analysis

5.5.1 Optimized Power Supply Configuration

Reliability worth analysis is optimized the reliability level with considering total cost of the power supply configurations. Forecasted capital investments are expected to increase against the improving reliability level of power supply configuration. Estimated investment cost of each options was forecasted by evaluating project costs in transmission planning reports. Those were published by CEB [26]. Table 5-17, 5-18 and 5-19 show estimated capital cost with reliability of each options.

TABLE 5-17 CAPTICAL COST ESTIMATE FOR OF KV LINE

Description	Reliability/ Interruption Duration (min/yr)	New Construction / Expansion Proposal	Estimated Cost (M LKR)	Total Estimated Cost (M LKR)
Option 1 (TSS is located at Pannipitiya GSS)	0.982994/ 10.86 min/yr	1. Augmentation of Pannipitiya GSS (2×132kV feeder bays as 2×132kV SB TF bay of TSS, 2×20MVA 132/25kV TF, 2× 25kV TF bay, 4×25kV feeder bays and 1×33kV bus section bay)	598.50	1,318.50
		2. Construct 4×25kV cable line (900m)	720.00	
Option 2 (TSS is located near the railway track)	0.981606/ 11.12 min/yr	1. Augmentation of Pannipitiya GSS (2×132kV feeder bays)	240.00	1,259.00
		2. Construct 2×132kV cable line (900m)	594.00	
		3. Construct new 132/25kV TSS near the railway track (2×20MVA 132/25kV TF, 2×132kV SB TF bay, 2× 25kV TF bay, 4×25kV feeder bays and 1×33kV bus section bay)	425.00	

According to this analysis, to reduce interruption duration by 0.25 min/year, an additional investment nearly 60 million LKR would be required. Option two was more appropriate with considering the incremental cost, augmentation of Pannipitiya GSS

and TSS construction. However, to select the most optimized option, other practical matters should be considered such as land acquisition, environmental concerns, construction, installation process, operational and maintenance procedures and, public safety.

TABLE 5-18 CAPITAL COST ESTIMATE FOR COASTAL LINE

Description	Reliability/ Interruption Duration (min/yr)	New Construction /Expansion Proposal	Estimated Cost (M LKR)	Total Estimated Cost (M LKR)
Option three (Feed from Ratmalana and Dehiwala GSS)	0.973097/ 15.59 min/yr	1. Construct new 132/25kV TSS near the railway track (2×25MVA 132/25kV TF, 2×132kV SB TF bay, 2× 25kV TF bay, 4×25kV feeder bays and 1×33kV bus section bay)	425.00	1,514.00
		2. Construct 132kV cable line Ratmalana to TSS(1.6km)	528.00	
		3. Construct 132kV cable line Dehiwala to TSS(1.7km)	561.00	
Option four (Feed TSS only using Ratmalana GSS)	0.968789/ 18.71 min/yr	1. Construct new 132/25kV TSS near the railway track (2×25MVA 132/25kV TF, 2×132kV SB TF bay, 2× 25kV TF bay, 4×25kV feeder bays and 1×33kV bus section bay)	425.00	1,481.00
		2. Construct 2×132kV cable line Ratmalana to TSS(1.6km)	1,056.00	
Option five (Feed TSS only using Dehiwala GSS)	0.960533/ 42.07min/yr	1. Construct new 132/25kV TSS near the railway track (2×25MVA 132/25kV TF, 2×132kV SB TF bay, 2× 25kV TF bay, 4×25kV feeder bays and 1×33kV bus section bay)	425.00	1,547.00
		3. Construct 2×132kV cable line Dehiwala to TSS(1.7km)	1,122.00	

Although, reliability was lower, option four was the most suitable due to lower capital cost than option three and five. According to this analysis, to reduce interruption duration by 3.12 min/year, an additional investment nearly 33 million LKR would be required. According to the minimum total cost analysis, most optimal option was also option four.

TABLE 5-19 CAPITAL COST ESTIMATION FOR MAIN & PUTTALAM LINE

Description	Reliability/ Interruption Duration (min/yr)	New Construction / Expansion Proposal	Estimated Cost (M LKR)	Total Estimated Cost (M LKR)
Option six <i>Feed TSS using existing network</i>	0.975858/ 25.57min/yr	1. Construct new 132/25kV near the railway track (2×25MVA 132/25kV TF, 2×132kV SB TF bay, 2× 25kV TF bay, 4×25kV feeder bays and 1×33kV bus section bay)	425.00	749.00
		2. Construct Zebra, 132kV, double cct. transmission line Aniyakanda to TSS (2.8km)	84.00	
		3. Augmentation of Aniyakanda GSS (2×132kV feeder bays)	240.00	
Option seven <i>Line in and out connection from Kotugoda - Kelaniya line</i>	0.983701/ 21.21min/yr	1. Construct new 132/25kV TSS near the railway track (2×25MVA 132/25kV TF, 2×132kV SB TF bay, 2× 25kV TF bay, 4×25kV feeder bays and 1×33kV bus section bay)	425.00	1,055.00
		2. Construct 2×132kV SB TL bays, 132kV SB arrangement including bus section	340.00	
		3. Single line in and out connection from Kotugoda - Kelaniya Line	230.00	
		4. Construct Zebra, 132kV, double cct. transmission line (2km)	60.00	
Option eight <i>Locate the TSS at Wanawasala and feed TSS from Kelaniya GSS</i>	0.988812/ 6.34min/yr	1. Construct new 132/25kV TSS near the railway track (2×25MVA 132/25kV TF, 2×132kV SB TF bay, 2× 25kV TF bay, 4×25kV feeder bays and 1×33kV bus section bay)	425.00	1,292.00
		2. Construct 132kV cable line Kelaniya to TSS (1.9km)	627.00	
		3. Augmentation of Kelaniya GSS (2×132kV feeder bays)	240.00	

Most suitable option cannot be selected without further analysis. Figure 5-7 shows the incremental reliability cost of power supply configurations. That figures out the reliability of each options in main & Puttalam lines against the capital cost estimation.

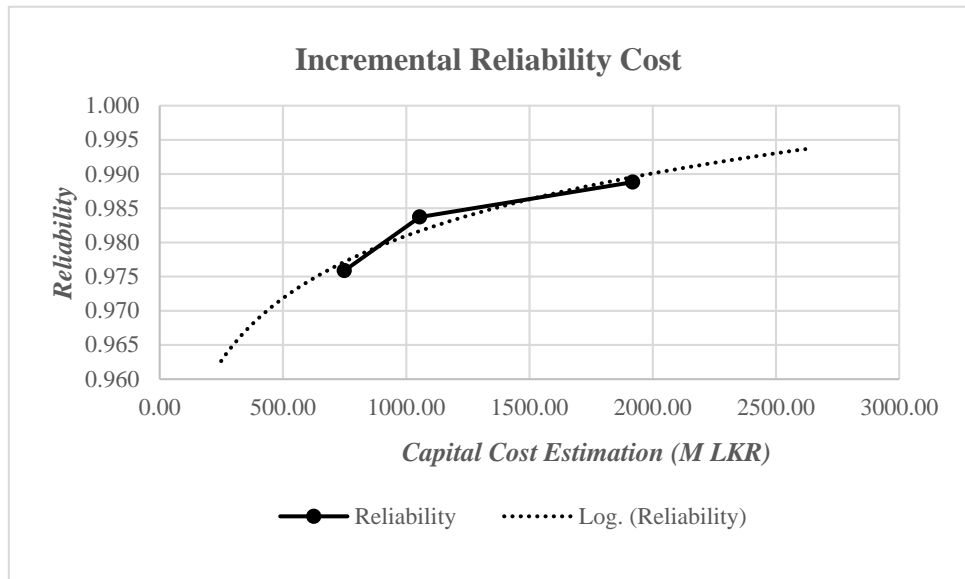

Figure 5-7 Incremental reliability cost of main & Puttalam lines

According to the final feasibility study report for KV line, option eight was ignored due to following reasons.

- Kelaniya GSS was too close to coastal and KV lines
- Aniyakanda GSS can serve both main & Puttalam lines
- Low fault level with Aniyakana GSS.

Therefore, the optimized option for main & Puttalam lines should be selected between options six and seven.

Interruption cost is frequently used as an indirect measurement of reliability worth assessment. The quantification of interruption costs is complex and often subjective task. Quantification of interruption cost was done using revenue loss due to unavailability of power and cost to facilitate the backup power to compensate the interruption. Customer impact should be taken into account by calculating the customer damage function. Customer satisfaction declines with delays and cancelation of trains.

Statistical data in the final feasibility study report for KV line, maximum passengers per train set was 1980. Average fare per passenger-km was LKR 2.99 which was calculated using the total ticket revenues of trains divided by the total number of

passenger-km of the operator. Maximum passenger km per year in main & Puttalam lines was around 1856×10^6 km. Then, maximum expected revenue from railway passenger per year was 5549.44 million LKR without any significant train delays and cancellations.

Revenue in electrified railway mostly depends on the punctuality of trains. Power failure is a critical factor for punctuality due to higher restoration time, snowball effect for train schedules, dissatisfaction among passengers. But, calculating the revenue loss due to power failure only was more complex. In this analysis, snowball effect and decline of passenger satisfaction due to power failure was assumed to be ten times of the interruption duration. Then, the maximum revenue loss due to power interruption in option six and seven were 2.7 million LKR/yr and 2.24 million LKR /yr, respectively. Table 5-20 summaries maximum revenue loss due to power interruption of option six and seven in main & Puttalam lines.

TABLE 5-20 REVENU LOSS CALCULATON OF MAIN & PUTTALAM LINES

Max. Passenger km (Million)	Average fare per passenger-km (LKR)	Revenue (M LKR/yr)	Interruption Duration (min/yr)	Revenue Loss (M LKR/yr)	Benefit (M LKR/yr)
1855.89	2.99	5549.12	25.57	2.70	0.46
			21.21	2.24	

When an interruption occurs, trains should be continued towards the next station with authorization from the signaling system and de-train his passengers safely using backup power options. In this calculation, standby generators were assumed to be the backup power option. However, standby generators were the most reliable and economical backup power option for CSRN. Detailed backup power option will be discussed in section 5.5.3.

Fuel cost calculation is shown in table 5-21. Then, table 5-22 shows expected interruption cost of options six and seven considering the fuel cost and composite customer damage function (CCDF). The revenue loss, snowball effect on the train schedule and decline of passenger satisfaction were included in the CCDF.

TABLE 5-21 FUEL COST AT INTERRUPTIO DURATION

Description	Unit	Amount
Fuel consumption of a 1.5MVA Generator	l/h	405.00
Fuel consumption of 4×1.5MVA Generators	l/h	1,620.00
Fuel price	LKR/l	95.00
Fuel cost for 6MVA Full load	LKR/h	153,900.00

TABLE 5-22 EXPECTED INTERRUPTION COST USING CCDF

Interruption Duration (min/yr)	Fuel cost (M LKR/yr)	CCDF (M LKR/yr)	Interruption Cost (M LKR/yr)
25.57	0.07	2.70	2.77
21.21	0.05	2.24	2.29

Expected interruption cost can be also calculated using Expected Energy Not Supply (EENS) and Interrupted Energy Assessment Rate (IEAR). According to the long-term generation expansion plan (2018-2037), Cost of Energy Not Served (CENS) was defined as “The average loss to the economy due to electrical energy not supplied has been estimated as 0.663 USD/kWh (in 2017 prices). This value has been derived by escalating the ENS figure given by PUCSL as 0.5 USD/kWh in 2011” [25]. Cost of Unserved Energy for Sri Lankan commercial and industries sector were considered as 324.80 LKR/kWh and 195.65 LKR/kWh at 2018 [31,32]. Therefore, CENS should be forecasted for 2025 by appropriately escalating the above figures. IEAR for electrified railway can be derived using CENS. Derivation is given below. Table 5-23 summaries the expected interruption cost calculation of main and Puttalam line feeding options using EENS and IEAR.

Cost of Energy Not Served (CENS) in 2018 = 0.663 USD/kWh

Cost of Energy Not Served (CENS) in 2025 = 0.663×1.25 LKR/kWh

Interrupted Energy Assessment Rate (IEAR)= 165.75×2/1000 LKR/MWh

= 0.3315 M LKR/MWh

TABLE 5-23 EXPECTED INTERRUPTION COST USING EENS AND IEAR

Interruption Duration (min/yr)	Apparent Power (MVA)	Active Power (MW)	Expected Energy Not Supplied (MWh/yr)	Interrupted Energy Assessment Rate (MLKR/MWh)	Expected Interruption Cost (M LKR/yr)
25.57	20	19	8.10	0.3315	2.68
21.21			6.72		2.23

$$\begin{aligned} \text{Average EIC of option six } (D_6) &= (2.68+2.77)/2 \text{ M LKR/yr} \\ &= 2.725 \text{ M LKR/yr} \end{aligned}$$

$$\begin{aligned} \text{Average EIC of option seven } (D_7) &= (2.23+2.29)/2 \text{ M LKR/yr} \\ &= 2.26 \text{ M LKR/yr} \end{aligned}$$

Minimum total cost assessment can be used to decide the optimal power feeding option in main & Puttalam lines under reliability worth assessment. Minimum total cost can be calculated using the investment, operating and expected interruption cost [6]. In general, 1%-2% of investment cost was considered as operating cost per year. Total cost of option six and seven are given below.

$$\text{Total Cost (Q)} = \text{Investment cost (I)} + \text{Operating cost (O)} + \text{Interruption cost (D)}$$

Annualized investment cost was calculated using the present value method considering 30-year life time and a 10% discount rate. I and A are annual investment cost and capital cost, respectively. Discount rate and economic life are denoted by i and n , respectively. Then, annual investment cost can be calculated using the following equation.

$$I = A \frac{i(1+i)^n}{(1+i)^n - 1}$$

$$\begin{aligned} \text{Annualized investment cost of option six } (I_6) &= 749.00 \times \frac{0.1(1+0.1)^{30}}{(1+0.1)^{30} - 1} \\ &= 749.00 \times 0.106079248 \\ &= 79.45 \text{ M LKR/yr} \end{aligned}$$

$$\begin{aligned}
\text{Annualized investment cost of option seven } (I_7) &= 1,055.00 \times \frac{0.1(1+0.1)^{30}}{(1+0.1)^{30}-1} \\
&= 1,055.00 \times 0.106079248 \\
&= 111.91 \text{ M LKR/yr} \\
\text{Annualized operating cost of option six } (O_6) &= 749.00 \times 2\% \\
&= 14.98 \text{ M LKR/yr} \\
\text{Annual operating cost of option six } (O_7) &= 1,055.00 \times 2\% \\
&= 21.10 \text{ M LKR/yr} \\
\text{Total cost of option six } (Q_6) &= I_6 + O_6 + D_6 \\
&= 79.45 + 14.98 + 2.725 \text{ M LKR/yr} \\
&= 97.155 \text{ M LKR/yr} \\
\text{Total cost of option seven } (Q_7) &= I_7 + O_7 + D_7 \\
&= 111.91 + 21.10 + 2.26 \text{ M LKR/yr} \\
&= 135.27 \text{ M LKR/yr}
\end{aligned}$$

According to the minimum total cost analysis, most optimal power supply option in main & Puttalam lines was option six.

Therefore, the most appropriate power supply configuration of KV, coastal and main & Puttalam lines were option two, four and six, respectively. Incremental cost analysis and the minimum total cost analysis were used for this evaluation. In addition, feasibility and detailed study recommendations were also considered in selecting of the optimal option.

5.5.2 Blackout Relief Options

There were four options for blackout relief. The following three options were evaluated to select most optimum alternative. Reliability and total cost analysis were done for this evaluation. Direct cable line to substation I from Kelanitissa GSS and

installation of battery bank were rejected due to higher capital cost, although reliability was better. Option two was proposed through this research as an alternative solution.

Most optimum option was installation of 6MVA backup generator due to following reasons,

- Higher reliable power feeding at the blackout conditions
- Power feeding within almost one minute after any power failure
- Opportunity for future expansions

TABLE 5-24 COST ANALYSIS OF BOR OPTIONS

Description	Reliability/ Interruption Duration (min/yr)	Newly Construction / Expansion Proposal	Estimated cost (M LKR)	Total Estimated Cost (M LKR)
OPTION 1 (Feed TSS using existing Network)	107.29	1. Augmentation of Colombo substation I (1×132kV feeder bays as 1×132kV SB TF bay of TSS, 7MVA 132/25kV TF, 1× 25kV TF bay, 2×25kV feeder bays)	269.33	269.33
OPTION 2 (Direct cable line to Sub I)	70.43	1. Construct 132kV cable line Kelanitissa to Sub I(6.8km)	2,244.00	2,513.33
		2. Augmentation of Colombo substation I (1×132kV feeder bays as 1×132kV SB TF bay of TSS, 7MVA 132/25kV TF, 1× 25kV TF bay, 2×25kV feeder bays)	269.33	
OPTION 3 (Backup Generator (6MVA))	-	1. Install backup Generator 4×1500kVA, 400V,50Hz	200.00	325.00
		2. Construction of generator supply (4×400V feeder bays and 1×400V bus section bay, 1×400V SB TF bay, 7MVA 400V/25kV TF, 1× 25kV TF bay, 1×25kV feeder bays)	125.00	

But, at the present condition, a prioritized power supply from Colombo Substation I is the most cost-effective and practical solution to initiate this project.

5.5.3 Reliability Benchmark for Power Supply Configuration of Electrified Railway in Sri Lanka

Optimum reliability of the power supply configurations to CSRN can be evaluated using minimum total cost analysis with considering all power feeding options of CSRN.

This evaluation can be used to establish a reliability benchmark for the power supply configuration of the electrified railway network in Sri Lanka.

Table 5-25 summaries CCDF due to power interruption of all options in KV, coastal and main & Puttalam lines.

TABLE 5-25 REVENUE LOSS CALCULATION OF CSRN FEEDING OPTIONS

Line	Max. Passenger km (Million)	Average fare per passenger-km (LKR)	Revenue (M LKR/yr)	Interruption Duration (min/yr)	CCDF (M LKR/yr)
KV line	942.40	2.99	2817.78	10.86	0.58
				11.12	0.60
Coastal line	1394.81		4170.48	15.59	1.24
				18.71	1.48
				42.07	3.34
Main & Puttalam lines	1855.89		5549.12	25.57	2.70
		21.21		2.24	
		6.34		0.67	

Table 5-26 shows expected interruption cost of power feeding options for CSRN using fuel cost and CCDF using fuel cost calculation in table 5-21.

Table 5-27 summaries the expected interruption cost calculation of CSRN feeding options using EENS and IEAR.

Table 5-28 shows average expected interruption cost of feeding options CSRN.

TABLE 5-26 EXPECTED INTERRUPTION COST OF CSRN USING CCDF

Power Feeding Options for CSRN	Interruption Duration (min/yr)	Fuel cost (M LKR/yr)	Max. Revenue Loss (LKR/yr)	Interruption Cost (M LKR/yr)
Option 1	10.86	0.03	0.58	0.61
Option 2	11.12	0.03	0.60	0.62
Option 3	15.59	0.04	1.24	1.28
Option 4	18.71	0.05	1.48	1.53
Option 5	42.07	0.11	3.34	3.45
Option 6	25.57	0.07	2.70	2.77
Option 7	21.21	0.05	2.24	2.29
Option 8	6.34	0.02	0.67	0.69

TABLE 5-27 EXPECTED INTERRUPTION COST OF CSRN USING EENS AND IEAR

Interruption Duration (min/yr)	Apparent Power (MVA)	Active Power (MW)	Expected Energy Not Supplied (MWh/yr)	Interrupted Energy Assessment Rate (LKR/MWh)	Expected Interruption Cost (M LKR/yr)
10.86	30	28.5	5.16	0.3315	1.71
11.12			5.28		1.75
15.59	25	23.75	6.17		2.05
18.71			7.41		2.46
42.07			16.65		5.52
25.57	20	19	8.10		2.68
21.21			6.72		2.23
6.34			2.01		0.67

TABLE 5-28 AVERAGE INTERRUPTION COST OF CSRN

Power Feeding Options for CSRN	Interruption Duration (min/yr)	Interruption Cost_CCDF (M LKR/yr)	Expected Interruption Cost_EENS (M LKR/yr)	Average Interruption Cost (M LKR/yr)
Option 1	10.86	0.61	1.71	1.16
Option 2	11.12	0.62	1.75	1.185
Option 3	15.59	1.28	2.05	1.665
Option 4	18.71	1.53	2.46	1.995
Option 5	42.07	3.45	5.52	4.483
Option 6	25.57	2.77	2.68	2.725
Option 7	21.21	2.29	2.23	2.26
Option 8	6.34	0.69	0.67	0.68

Figure 5-8 shows expected interruption cost of CSRN. Option five was ignored due to lower reliability and higher interruption duration.

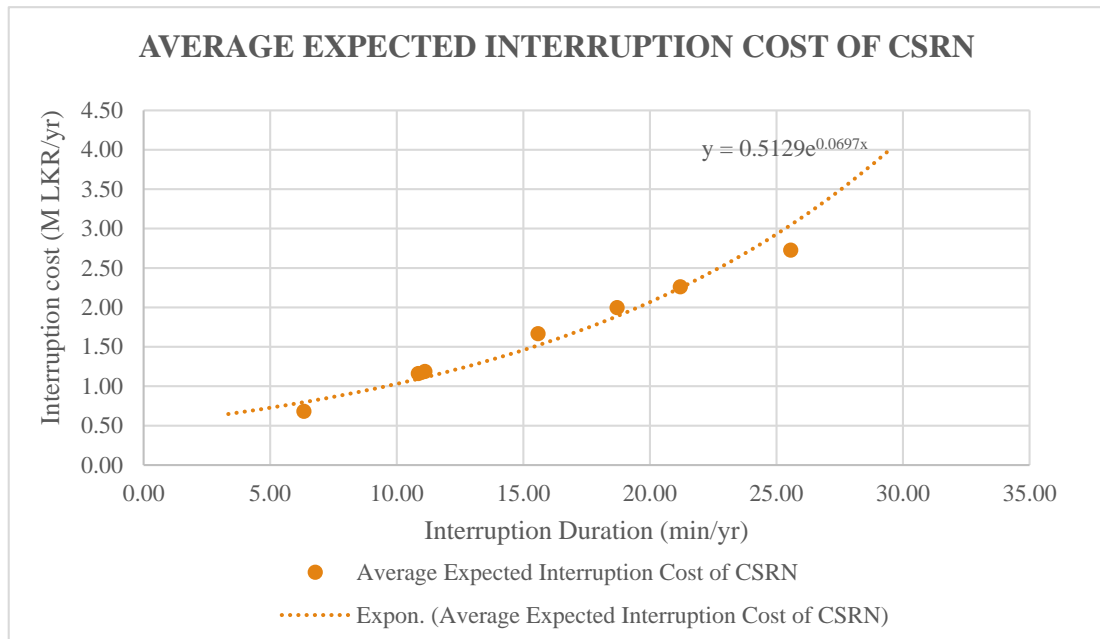

Figure 5-8 Expected interruption cost of CSRN

Annualized investment cost and average expected interruption cost of each power feeding options in CSRN are summarized in table 5-29. Annualized investment cost was calculated using the present value method, considering a 30 year life time and, 10% discount rate. Figure 5.29 shows reliability worth curve against interruption duration. Table 5-30 summarizes the minimum total cost of each of the power feeding options.

TABLE 5-29 ANNUALIZED COST OF CSRN

Power Feeding Options	Interruption Duration (min/yr)	Average Expected Interruption Cost of CSRN (M LKR/yr)	Capital Cost Estimation (M LKR)	Annualized Investment Cost of CSRN (M LKR/yr)
Option 1	10.86	1.16	1318.50	139.87
Option 2	11.12	1.19	1259.00	133.55
Option 3	15.59	1.67	1514.00	160.60
Option 4	18.71	2.00	1481.00	157.10
Option 6	25.57	2.73	749.00	79.45
Option 7	21.21	2.26	1055.00	111.91
Option 8	6.34	0.68	1919.00	203.57

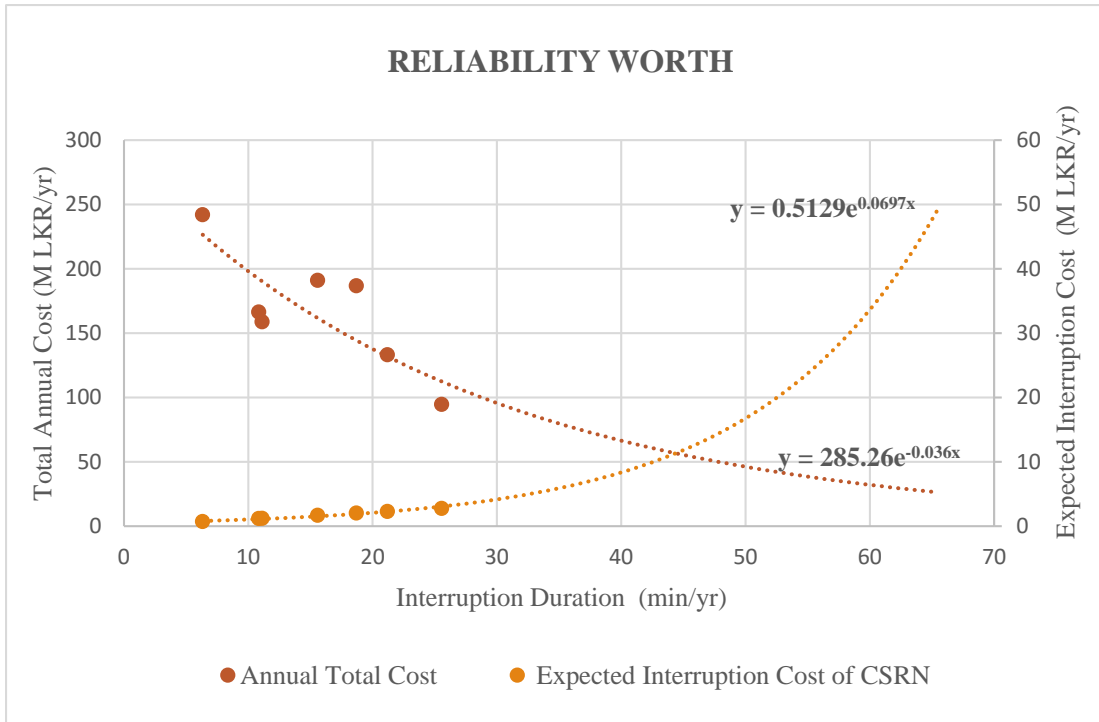

Figure 5-9 Reliability worth curve

Then annual total cost of CSRN were calculated using following equation. Two percent of investment cost was considered as operating cost.

$$\text{Total Cost (Q)} = 0.5129e^{0.0697x} + 285.26e^{-0.036x}$$

Figure 5-9 shows minimum total annual cost analysis of each power feeding options of CSRN with interruption duration.

TABLE 5-30 MINIMUM TOTAL COST CALCULATION OF CSRN

Power Feeding Options	Annual Investment Cost of CSRN (M LKR/yr)	Operating Cost of CSRN (M LKR/yr)	Average Expected Interruption Cost of CSRN (M LKR/yr)	Total Annual Cost of CSRN (M LKR/yr)
Option 1	139.87	26.37	1.16	167.40
Option 2	133.55	25.18	1.19	159.92
Option 3	160.60	30.28	1.67	192.55
Option 4	157.10	29.62	2.00	188.72
Option 6	79.45	21.10	2.73	135.27
Option 7	111.91	14.98	2.26	97.16
Option 8	203.57	38.38	0.68	242.63

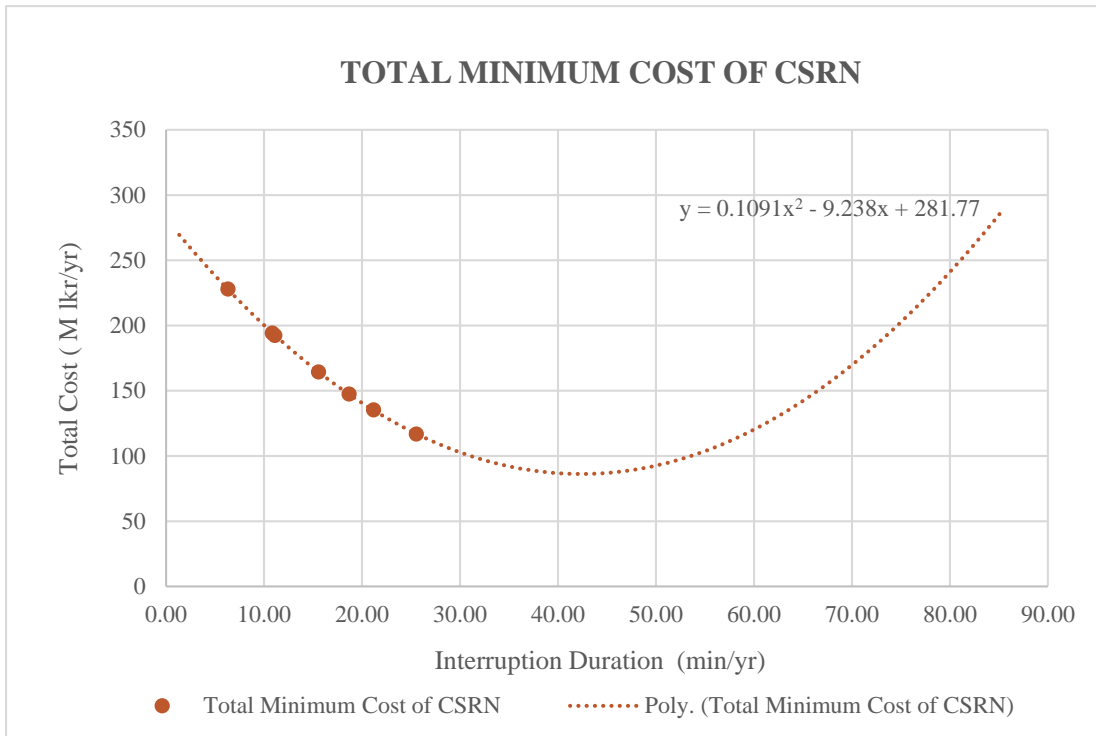

Figure 5-10 Minimum total cost analysis of CSRN

According to the minimum total cost analysis, minimum total cost was at 42.33 min/yr interruption duration.

Therefore, 40 min/yr interruption duration can be established as interruption duration benchmark in Sri Lanka electrified railway system. However, according to draft grid code LOLP maximum value was 1.5%. Then, cumulative failure duration for the generating system was 5.5 days/year [25].

According to Rail Market Monitoring Survey, a train was defined as punctual if it was less than five minutes late, but definitions vary between states and types of service. For example, Germany reported that a train was defined as punctual if it was less than six minutes late (up to 5 minutes 59 seconds late) [33]. According to the international norms, power supply failures were less impact to punctuality of electrified trains (6%) with considering signaling, telecommunication, track and other failures [34].

6. CONCLUSIONS AND FUTURE DIRECTIONS

6.1 Conclusions

Colombo suburban railway project was based on this research. Integrated reliability assessment model was developed for reliability evaluation.

The integrated reliability assessment model including the reliability model of the grid substation, sub-transmission network and the traction substation were developed to evaluate of reliability indices of power supply configurations for the electrified railways.

Simplification of the model was performed to improve the effectiveness of the model without seriously affecting the end results.

Reliability indices of power supply configurations for KV, coastal and main & Puttalam lines in CSRN were evaluated using the developed model.

The effectiveness of the model was verified comparing model results with Monte Carlo simulation.

Reliability worth analysis was implemented to select the most optimal power supply configuration of each electrified railway line. As per the results of the analysis, most appropriate power supply configuration of KV, coastal and main & Puttalam lines were option two (TSS location at near to railway line), three (power feed from both Ratmalana and Dehiwala GSS) and six (power feed using existing network), respectively.

Interruption duration benchmark was established as forty minute per year for power supply configuration of electrified suburban railway network in Sri Lanka. But, electrified train was defined as punctual if it was less than five minutes late.

6.2 Future Directions

A simplified integrated reliability assessment model can be used for any other electrified railway applications and modified model without the reliability model of the TSS. It can be used for reliability assessment of GSS, transmission network, bulk power feeding configuration, etc.

In this research, reliability assessment was done manually. But this model can be developed as power system reliability assessment software using a few inputs such as power system network, failure rate and MTTR of individual components.

REFERENCES

- [1] D.J.Wimalasurendra, "Economics of Power Utilization I Ceylon", Transaction of The Engineering Association of Ceylon, 1918.
- [2] "Final Report, Panadura – Veyangoda Initial Feasibility Report, Volume 1- Main Report", Egis International/Resource Development Consultants (Pvt) Ltd, Colombo, 2018.
- [3] "Final Feasibility Study Report for KV Line", DOHWA Engineering Co. Ltd in JV with Oriental Consultants Global, Colombo, 2018.
- [4] R. Billinton and R. N. Allan, *Reliability evaluation of engineering systems: concepts and techniques*, 2Nd ed. New York: Plenum Press, 1992.
- [5] R. Billinton, and R. N. Allan, *Reliability Evaluation of Power Systems*, Pitman Books, New York and London, 1984.
- [6] R. Billinton, and W Li, *Reliability Assessment of Electric Power Systems Using Monte Carlo Methods*, Plenum Press, New York, 1994.
- [7] Z. Krishans, A. Kutjuns and M. Kalnins, "Method of transmission power networks reliability estimation", in 2007 IEEE Lausanne Power Tech, 2007.
- [8] Shi Xiao-qiang, Wang Hao, Bai Heng-yuan, Wang Tian-hua, Gao Ke and Wang Yan-min, "Study on the evaluation model and method of power transmission system reliability", in 2016 Tsinghua University-IET Electrical Engineering Academic Forum, 2016.
- [9] Fang Yang, A.P.S. Meliopoulos, G.J. Cokkinides and G. Stefopoulos, "A bulk power system reliability assessment methodology", in 2004 International Conference on Probabilistic Methods Applied to Power Systems, 2004.
- [10] Fang Yang, A. P. Sakis Meliopoulos, George J. Cokkinides and George K. Stefopoulos, "A Comprehensive Approach for Bulk Power System Reliability Assessment", in 2007 IEEE Lausanne Power Tech, 2007.
- [11] Y. Miao, W. Luo, W. Lei, P. Zhang, R. Jiang, and X. Deng, "Power supply reliability indices computation with consideration of generation systems, transmission systems and sub-transmission systems load transfer

- capabilities,” 2016 IEEE PES Asia-Pacific Power and Energy Engineering Conference (APPEEC), 2016.
- [12] Y. Yuan, W. J. Yong, and X. J. Jian, “Reliability evaluation of a bulk power system for the traction power supply system of a high-speed railway,” 2009 Annual Reliability and Maintainability Symposium, 2009.
- [13] Fang Yang, A. P. Sakis Meliopoulos, George J. Cokkinides and George K. Stefopoulos, "A Comprehensive Approach for Bulk Power System Reliability Assessment", in 2007 IEEE Lausanne Power Tech, 2007.
- [14] Evelina Rakhmetova, Vladimir Moiseenko, Lorenzo Damiani, Olga Ivanova, Mikhail Ivanov and Roberto Revetria, "A Reliability Evaluation of High-Speed Railway Traction System Based on Failure Effect Analysis", in Proceedings of the International MultiConference of Engineers and Computer Scientists 2018, 2018.
- [15] Ding Feng, Zhengyou He and Qi Wang, "A reliability assessment method for traction transformer of high-speed railway considering the load characteristics", in 2015 IEEE Conference on Prognostics and Health Management (PHM), 2015.
- [16] S. Sagareli. “Traction Power Systems Reliability Concepts”. Proc. of the 2004 ASME/IEEE Joint Rail Conference, April 6-8, 2004, Baltimore, Maryland, USA, Vol.1:35-39
- [17] S.K.Chen, T.K.Ho and B.H.Mao, "Reliability evaluations of railway power supplies by fault-tree analysis", in IET Electr. Power Appl., 2007.
- [18] MATSUOKA Takeshi, "A Monte Carlo simulation method for system reliability analysis", 2013.
- [19] Andrea M. Rei, Marcus Th. Schilling and Albert C. G. Melo, "Monte Carlo Simulation and Contingency Enumeration in Bulk Power Systems Reliability Assessment", in 2006 International Conference on Probabilistic Methods Applied to Power Systems, 2006.
- [20] R. Billinton and A. Sankarakrishnan, "A comparison of Monte Carlo simulation techniques for composite power system reliability assessment", in IEEE WESCANEX 95. Communications, Power, and Computing. Conference Proceedings, 1995.

- [21] Na Li, Zhenhua Zhu, Ming Li, Ying Lin, Xiaoliang Wang and Qinglong Liu, "Research on reliability evaluation of power system including improved Monte Carlo and parallel calculation", in 2017 2nd International Conference on Power and Renewable Energy (ICPRE), 2017.
- [22] Alireza Heidari, Vassilios G. Agelidis, Josep Pou, Jamshid Aghaei and Amer M. Y. M. Ghias, "Reliability Worth Analysis of Distribution Systems using Cascade Correlation Neural Networks", in IEEE Transactions on Power Systems, 2018.
- [23] D. Karlsson, L. Wallin, H.-E. Olovsson and C.-E. Solver, "Reliability and life cycle cost estimates of 400 kV substation layouts", in IEEE Transactions on Power Delivery, 1997.
- [24] Hui Hui, Sige Liu, Mingxin Zhao and Hai Chen, "The Reliability and Economic Assessment Methods for Main Electrical Connection in Substation Considering Adapting to Power Grid Development", in IEEE PES Innovative Smart Grid Technologies, 2012.
- [25] Ceylon Electricity Board, "LONG TERM GENERATION EXPANSION PLAN 2018-2037", Transmission and Generation Planning Branch Transmission Division Ceylon Electricity Board Sri Lanka, Colombo, 2018.
- [26] Ceylon Electricity Board, "LONG TERM TRANSMISSION DEVELOPMENT PLAN 2013 - 2022", Transmission Planning Section Transmission and Generation Planning Branch Transmission Division Ceylon Electricity Board, Colombo, 2013.
- [27] Ceylon Electricity Board, "SALES AND GENERATION DATA BOOK 2017", Statistical Unit Corporate Strategy & Regulatory Affairs Branch, Ceylon Electricity Board, Colombo, 2017.
- [28] Ceylon Electricity Board, "Statistical Digest 2017", Ceylon Electricity Board, Colombo, 2017.
- [29] L. Widanagama Arachchige, T. Siyambalapitiya, J. Lucas and S. Thotagamuwage, "Design of the power feeding system for electrified railways case study: Panadura -Veyangoda railway sector", MSc., University of Moratuwa, 2018.

- [30] 493-2007 - IEEE Recommended Practice for the Design of Reliable Industrial and Commercial Power
- [31] D. Punsara Coloambage and H.Y. Ranjit Perera, "Assessment of Cost of Unserved Energy for Sri Lankan Commercial Sector", in Moratuwa Engineering Research Conference (MERCon), University of Moratuwa, 2018.
- [32] D. Punsara Coloambage and H.Y. Ranjit Perera, "Assessment of Cost of Unserved Energy for Sri Lankan Industrial Sector", in Moratuwa Engineering Research Conference (MERCon), University of Moratuwa, 2018.
- [33] "REPORT FROM THE COMMISSION TO THE EUROPEAN PARLIAMENT AND THE COUNCIL", European Commission, 2019.
- [34] "INTERNATIONAL BENCHMARK 2011 – 2015 PRORAIL / NS", ProRail and NS, Nederland, 2017.

ANNEX A – SINGLE LINE DIAGRAM OF TRACTION SUBSTATION

SIMPLIFIED INDICATIVE SINGLE LINE DIAGRAM

LEGEND :

SYMBOL	DESCRIPTION
	SHUNT SURGE ARRESTERS
	CIRCUIT BREAKER
	CURRENT TRANSFORMER
	CAPACITOR VOLTAGE TRANSFORMER
	ISOLATOR (PTI-210)
	20kV THREE POSITION ISOLATOR
	POWER TRANSFORMER
	EARTHING SWITCH
	POTENTIAL TRANSFORMER
	20kV TYPE ISOLATOR
	AMMETER
	VOLTMETER
	ELECTRICAL INTERLOCKING
	RELAY OPERATOR
	20kV AIR FUSE
	ISOLATOR

INCOMING CEB 132kV CIRCUIT 2

INCOMING CEB 132kV CIRCUIT 1

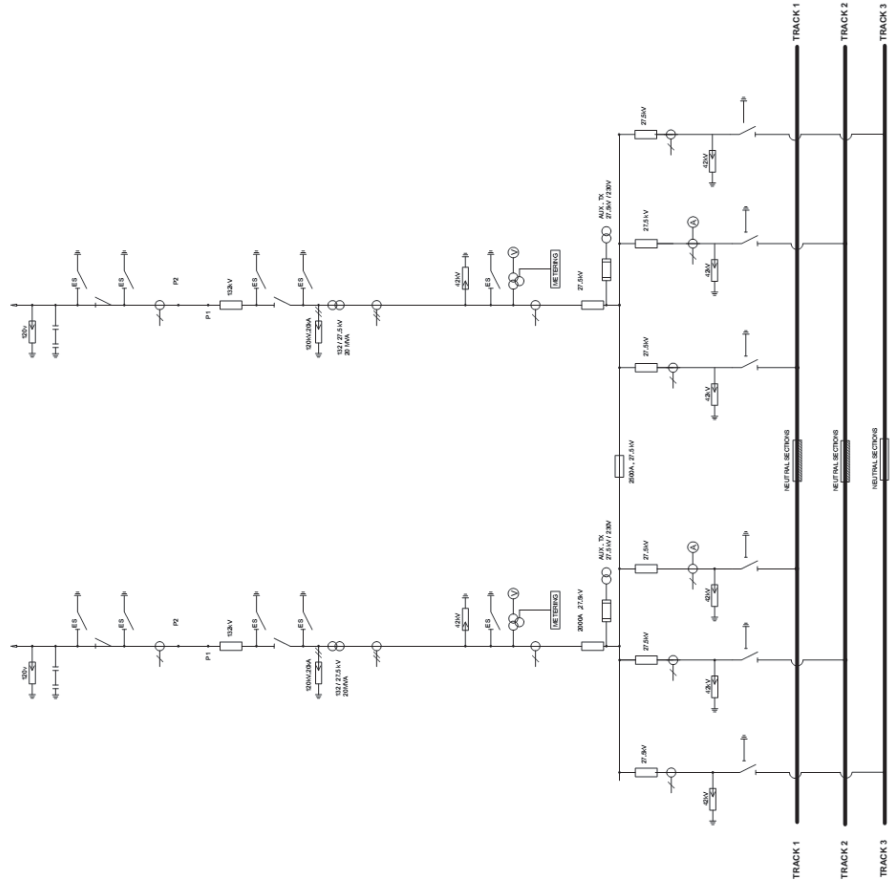

The Map of Sri Lanka Transmission System in Year 2018

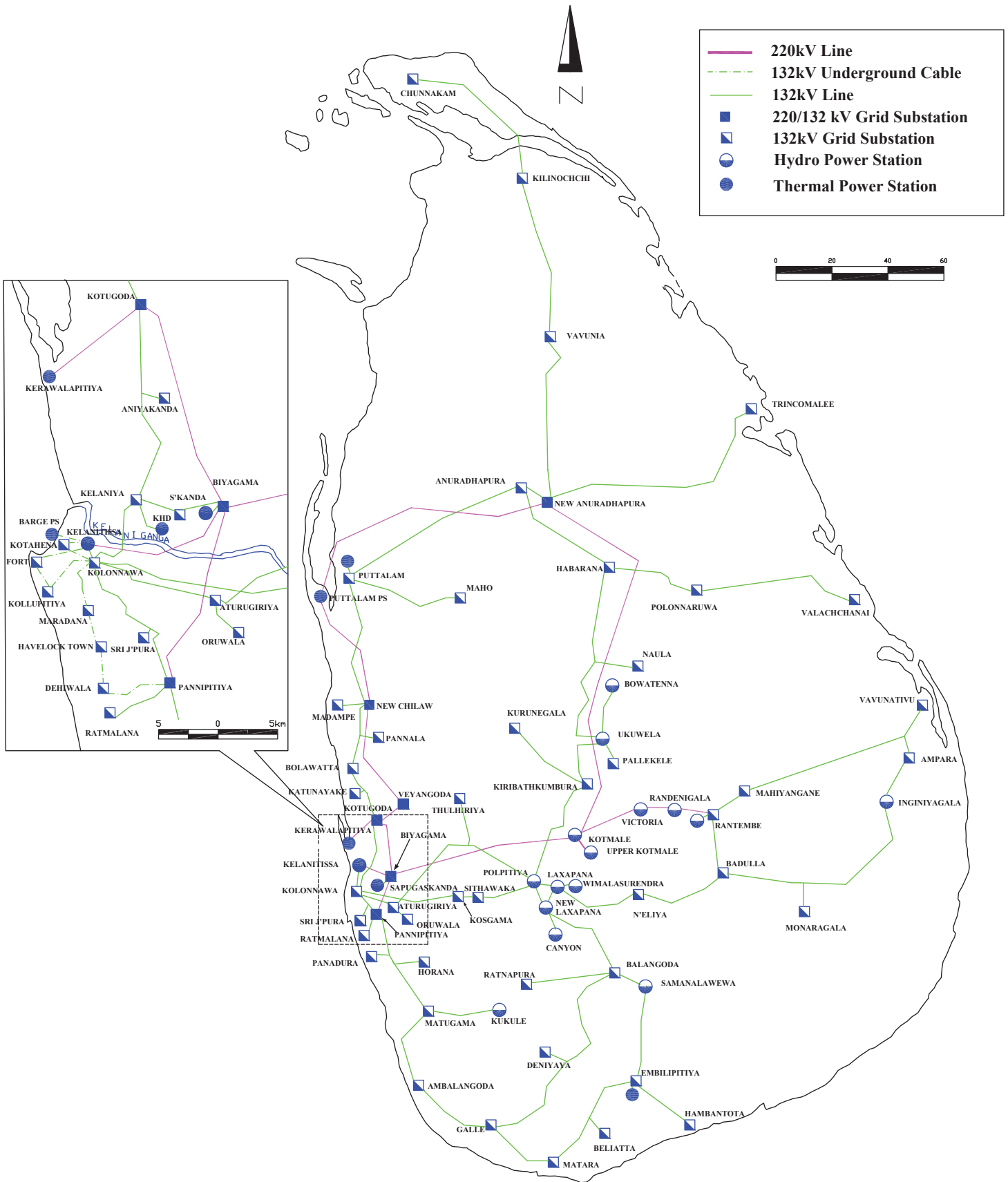



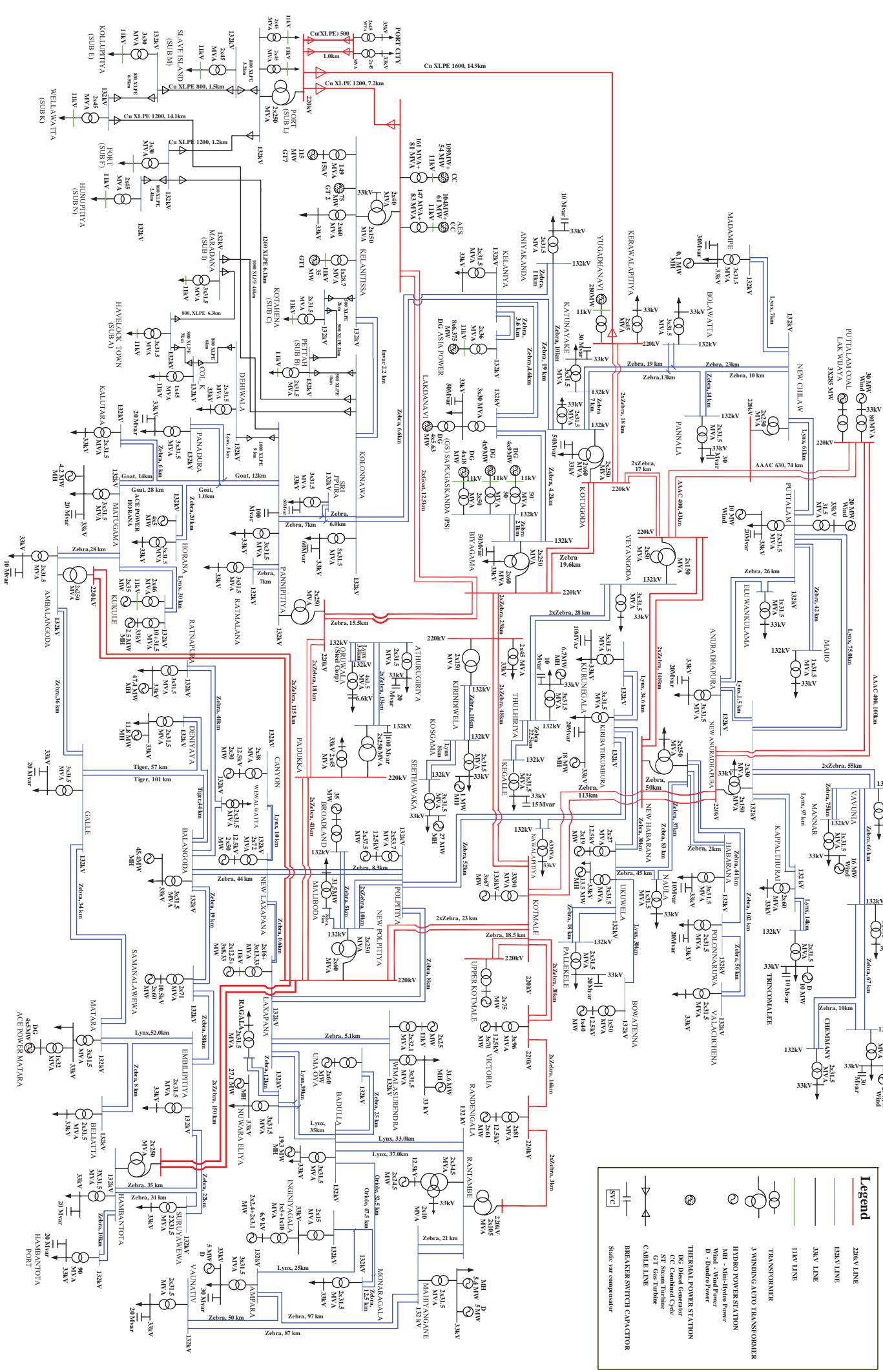

ANNEX D - SCHEMATIC DIAGRAM OF 2017 TRANSMISSION SYSTEM

Schematic Diagram of the 2017 Transmission System























ANNEX E - COLOMBO SUBURBAN RAILWAY NETWORK AND PROPOSED FEEDING SUBSTATION

COLOMBO SUBURBAN RAILWAY NETWORK

-  Maradana-Fort Maradana-
-  veyangoda line Fort to
-  Panadura Ragama to
-  Negombo Maradana -
-  Avissawella

CEB GRID SUBSTATION

-  1. **Ratmalana Grid Substation**
-  2. Kelaniya GSS
-  3. Seethawaka GSS
-  4. Colombo C Grid Substation
-  5. Panadura GSS
-  6. **Aniyakanda GSS**
-  7. Sapugaskanda GSS
-  8. Biyagama GSS
-  9. Athurugiriya GSS
-  10. E Grid Sub CEB
-  11. Kelanitissa Power Station
-  12. Kosgama GSS
-  13. Kotugoda GSS
-  14. Veyangoda GSS
-  15. **Pannipitiya GSS**
-  16. Katunayake GSS
-  17. **Dehiwala GSS**
-  18. Colombo B GSS
-  19. Kolonnawa New GSS
-  20. **Colombo I GSS**
-  220kV/132kV GSS
-  132kV /33kV GSS

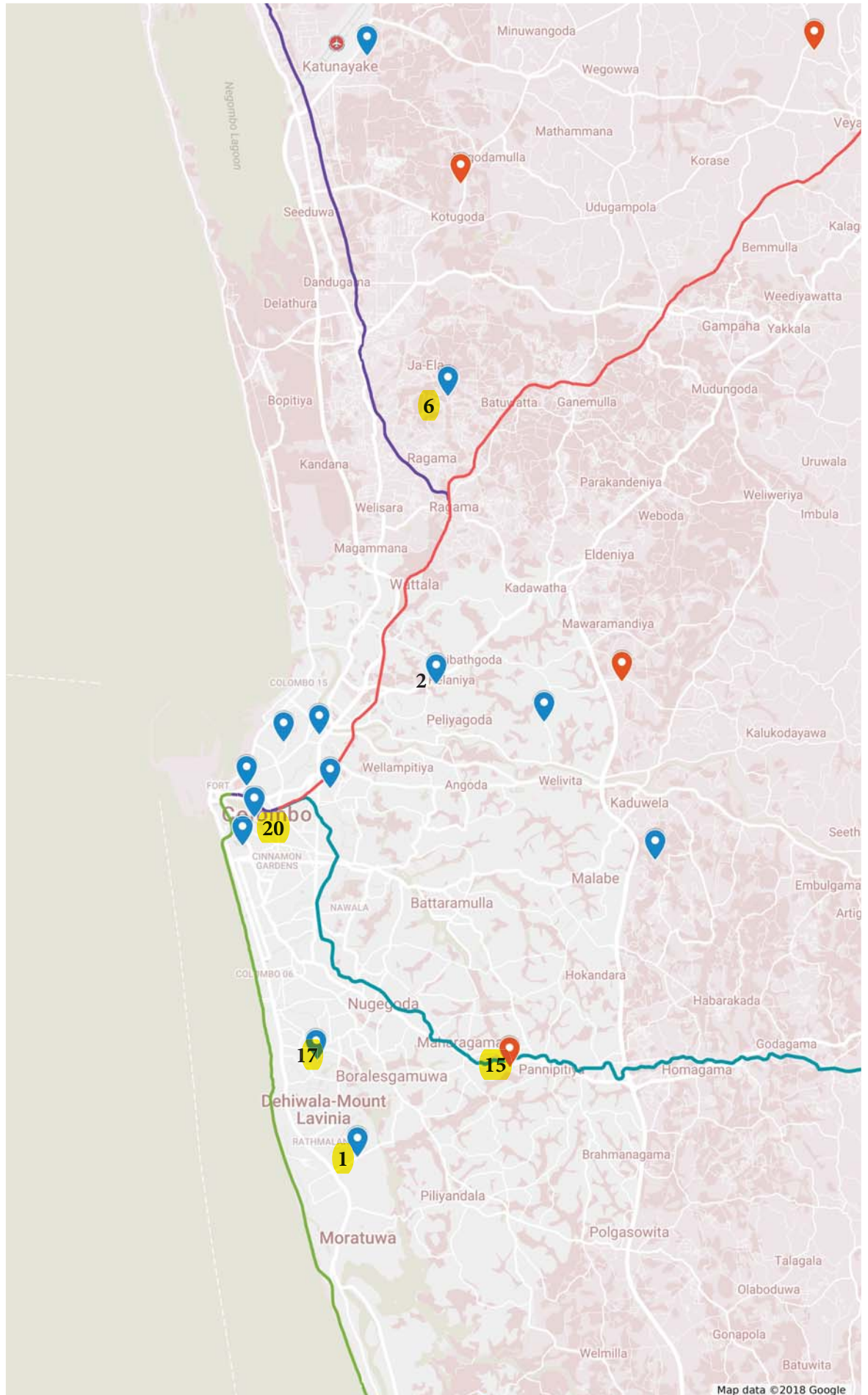

ANNEX F - CSRP FEEDING OPTIONS FROM SCHEMATIC DIAGRAM OF THE 2022 TRANSMISSION SYSTEM

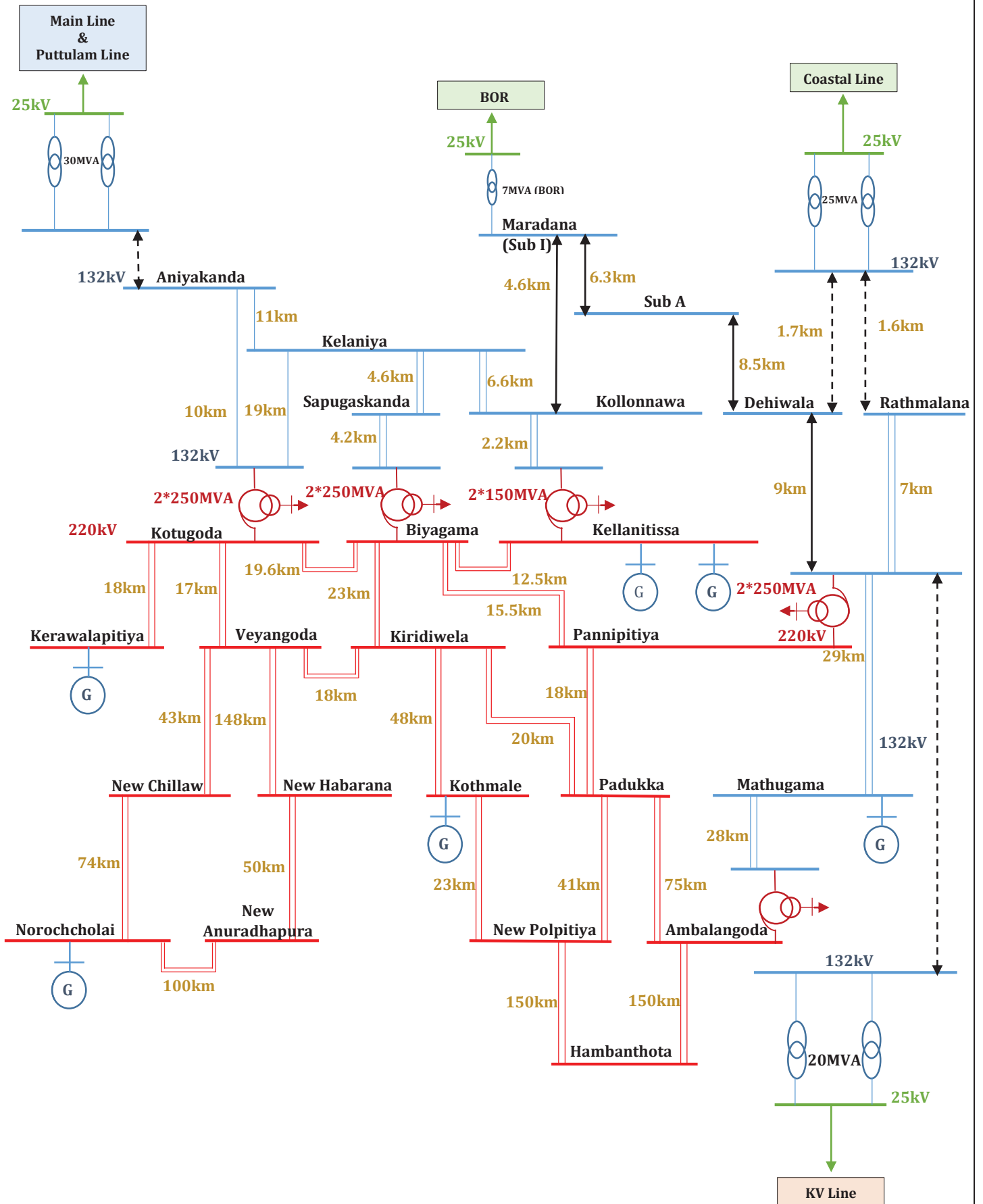

ANNEX G - RELIABILITY DIAGRAM OF CSRP FEEDING OPTIONS

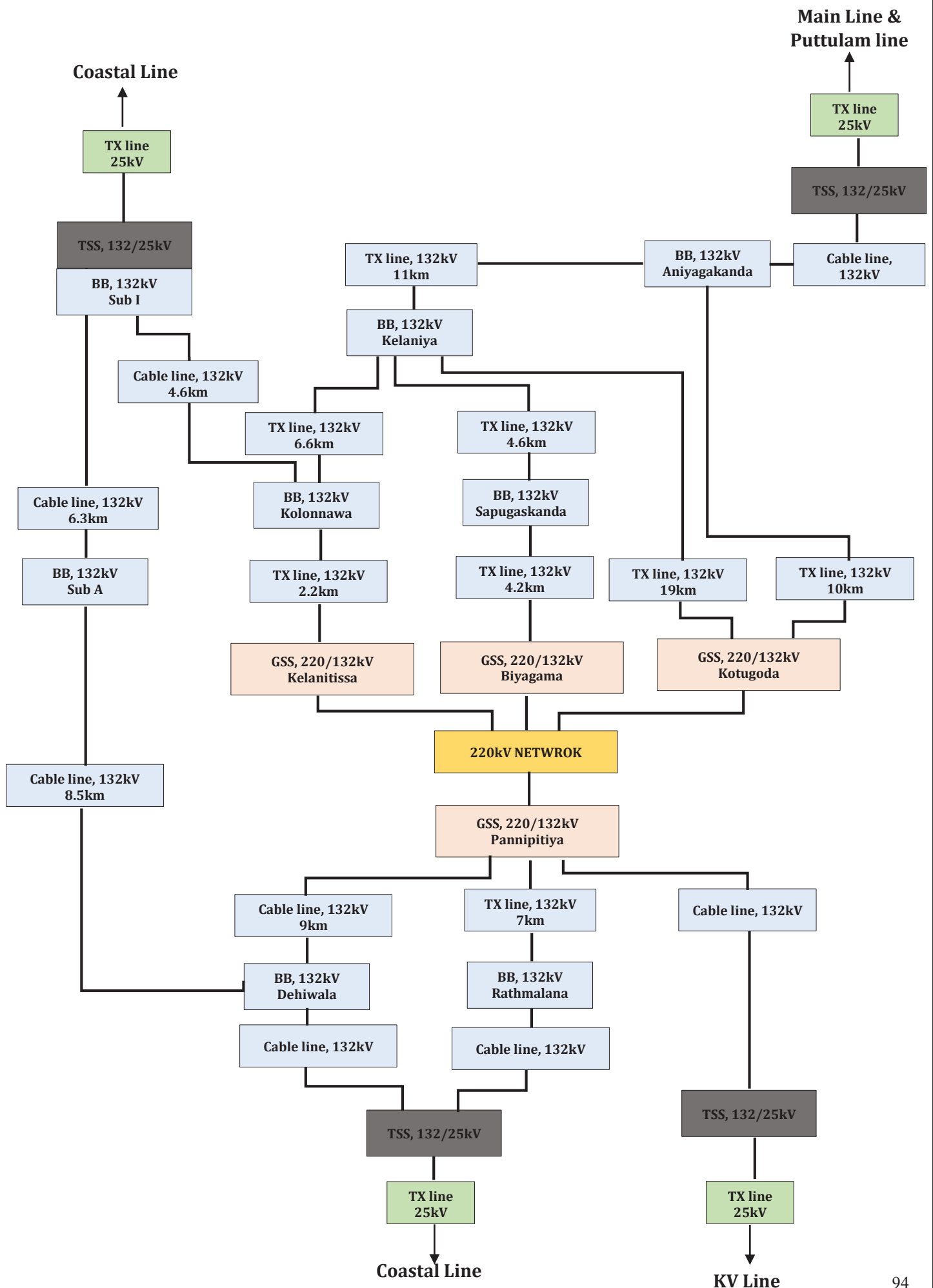

ANNEX H - RELIABILITY INDICES EVALUATION OF KV LINE FEEDING OPTION ONE AND TWO

KV Line			
Option	Availability	Interruption Duration(min/yr)	Reliability
OPTION 1	0.9999793294	10.86	0.982994
OPTION 2	0.9999788463	11.12	0.981606

OPTION 1 - TSS is located at Pannipitiya GSS					
Description	GSS, 220/132kV Pannipitiya	Cable line, 132kV	TSS, 132/25kV	TX line, 25kV	KV Line
Failure Rate, λ	0.017148494	0.0000001857	0.000003445		0.017152126
MTTR ,r	10.5574	1.63	8.79		10.56

BB, HV SIDE [LINE BAY + BB(HV)]				
220kV Line Bay + Pannipitiya 220kV BB	Description		Failure Rate, λ (f/yr)	MTTR ,r
	BBHV			0.0085731918
No. of Parral Lines		2	0.0000001857	1.6291
<i>LINE BAY</i>	LB,s		<i>0.0158</i>	3.2582
	<i>ISO+ES</i>		<i>0.0061</i>	3.6
	<i>CB</i>		<i>0.0036</i>	2.1
	<i>ISO</i>		<i>0.0061</i>	3.6
<i>BB(HV)</i>	BBH		0.008573006	10.6
	<i>BB</i>		<i>0.008573006</i>	10.6

GSS [TRANSFORMER BAY + BB(LV)]				
Pannipitiya Transformer Bay + 132kV BB	Description		Failure Rate, λ (f/yr)	MTTR ,r
	GSS			0.008575303
No. of Parral Lines		2	0.000002296	10.0232
<i>TRANSFORMER BAY</i>	TB,s		<i>0.0224</i>	20.0464
	<i>ISO</i>		<i>0.0061</i>	3.6
	<i>CB</i>		<i>0.0036</i>	2.1
	<i>TRANFO</i>		<i>0.0030</i>	130.0
	<i>CB</i>		<i>0.0036</i>	2.1
	<i>ISO+ES</i>		<i>0.0061</i>	3.6
<i>BB(LV)</i>	BBL		0.008573006	10.6
	<i>BB</i>		<i>0.008573006</i>	10.6

TX LINE [FEEDER BAY + LINE]				
Pannipitiya 132kV Feeder Bay + 132kV Cable Line	Description		Failure Rate, λ (f/yr)	MTTR ,r
	TXL			0.0000001857
No. of Parral Lines		2	0.0000001857	1.6291
<i>FEEDER BAY</i>	FB,s		0.0158	3.2582
	<i>ISO</i>		<i>0.0061</i>	3.6
	<i>CB</i>		<i>0.0036</i>	2.1
	<i>ISO+ES</i>		<i>0.0061</i>	3.6
<i>LINE</i>	L			

TSS Transformer Bay + 25kV BB TSS + 25kV Feeder Bay + 25kV Cable Line	TSS [TRANSFORMER BAY + BB(LV)+TX LINE]			
	Description		Failure Rate, λ (f/yr)	MTTR ,r
	GSS		0.000003445	8.7890
	No. of Parral Lines	2	0.000003445	8.7890
	TRANSFORMER BAY	TB,s	0.0293	17.5780
		ISO+ES	0.0061	3.6
		CB (MV)	0.0036	2.1
		ISO+ES	0.0061	3.6
		TRANFO(132/25kV)	0.0030	130.0
		ISO	0.0061	3.6
CB(LV)		0.0027	4.0	
BB(LV)	BB	0.0017	24.0	
TX LINE		0.000000364	4.9637	
No. of Parral Lines	2	0.000000364	4.9637	
FEEDER BAY	FB,s	0.0127	9.9274	
	CB	0.0027	4.0	
	ISO+ES	0.0061	3.6	
LINE	L	0.00388	24.0	

OPTION 2 - TSS is located at near to Railway system					
Description	GSS, 220/132kV Pannipitiya	Cable line, 132kV	TSS, 132/25kV	TX line, 25kV	KV Line
Failure Rate, λ	0.017148494	0.001413099	0.000003445		0.018565
MTTR ,r	10.5574	3.00	8.79		9.98

220kV Line Bay + Pannipitiya 220kV BB	BB, HV SIDE [LINE BAY + BB(HV)]			
	Description		Failure Rate, λ (f/yr)	MTTR ,r
	BBHV		0.0085731918	10.55738
	No. of Parral Lines	2	0.0000001857	1.6291
	LINE BAY	LB,s	0.0158	3.2582
		ISO+ES	0.0061	3.6
		CB	0.0036	2.1
		ISO	0.0061	3.6
	BB(HV)	BBH	0.008573	10.6
		BB	0.008573	10.6

Pannipitiya Transformer Bay + 132kV BB	GSS [TRANSFORMER BAY + BB(LV)]			
	Description		Failure Rate, λ (f/yr)	MTTR ,r
	GSS		0.008575303	10.5574
	No. of Parral Lines	2	0.000002296	10.0232
	TRANSFORMER BAY	TB,s	0.0224	20.046
		ISO	0.0061	3.6
		CB	0.0036	2.1
		TRANFO	0.003	130.0
		CB	0.0036	2.1
		ISO+ES	0.0061	3.6
BB(LV)		BBL	0.008573	10.6
	BB	0.008573	10.6	

Pannipitiya 132kV Feeder Bay + 132kV Cable Line	TX LINE [FEEDER BAY + LINE]			
	Description		Failure Rate, λ (f/yr)	MTRR ,r
	TXL		0.001413099	2.9951
	No. of Parral Lines	2	0.001413099	2.9951
	FEEDER BAY	FB,s	1.0165	5.9902
		ISO	0.0061	3.6
CB		0.0036	2.1	
	ISO+ES	0.0061	3.6	
LINE	L	1.0007	6.0333	

	TSS [TRANSFORMER BAY + BB(LV)+TX LINE]			
	Description		Failure Rate, λ (f/yr)	MTRR ,r
	GSS		0.000003445	8.7890
	Lines	2	0.000003445	8.7890
	TRANSFORMER BAY	TB,s	0.0293	17.5780
		ISO+ES	0.0061	3.6
		CB (MV)	0.0036	2.1
		ISO+ES	0.0061	3.6
		TRANFO(132/25kV)	0.0030	130.0
		ISO	0.0061	3.6
		CB(LV)	0.0027	4.0
	BB(LV)	BB	0.0017	24.0
	TX LINE		0.000000364	4.9637
	No. of Parral Lines	2	0.000000364	4.9637
	FEEDER BAY	FB,s	0.0127	9.9274
		CB	0.0027	4.0
ISO+ES		0.0061	3.6	
LINE	L	0.00388	24.00	

KV Line Feeding Options from Schematic Diagram of the 2017 Transmission System

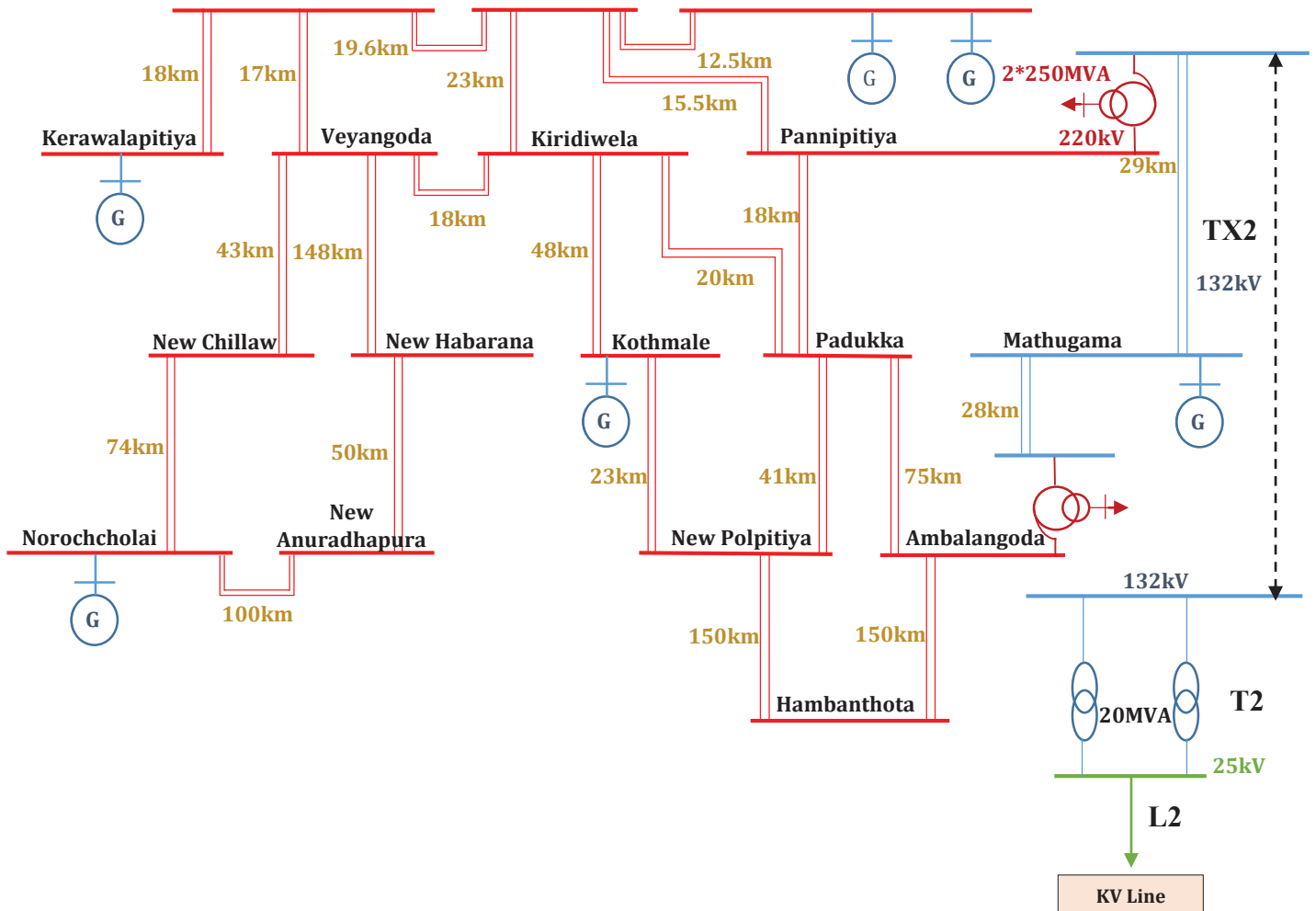

**ANNEX I - RELIABILITY INDICES EVALUATION OF COASTAL LINE FEEDING
OPTION THREE, FOUR AND FIVE**

Coastal Line			
Option	Availability	Interruption Duration(min/yr)	Reliability
OPTION 1	0.999970339	15.59	0.97309687
OPTION 2	0.998857015	18.71	0.96878931
OPTION 3	0.999919957	42.07	0.96053331

OPTION 3 - Feed from Rathmalana and Dehiwal GSS					
Description	GSS, 220/132kV Pannipitiya	Cable line, 132kV	TSS, 132/25kV	TX line, 25kV	Coastal Line
Failure Rate, λ	0.01715	0.01011971	0.000003445		0.02727
MTTR ,r	10.557	7.783	8.789		9.5276

Description	GSS, 220/132kV Pannipitiya	Cable line, 132kV		TSS, 132/25kV	TX line, 25kV
Failure Rate, λ		2.0432			
MTTR ,r		31.8022			
		TX line, 132kV			
Failure Rate, λ	0.01715	1.03042		0.000003445	
MTTR ,r	10.557	10.3046		8.7890	

Description	GSS, 220/132kV Pannipitiya	Cable line, 132kV	BB, 132kV- Dehiwal	Cable line, 132kV	TSS, 132/25kV	TX line, 25kV
Failure Rate, λ		1.0165	0.01020	1.01649		
MTTR ,r		53.507	26.7995	10.148		
		TX line, 132kV	BB, 132kV Rathmalana	Cable line, 132kV		
Failure Rate, λ	0.01715	0.003729198	0.0102	1.01649	0.000003445	
MTTR ,r	10.5574	7.9108	26.7995	10.1479	8.7890	

220kV Line Bay + Pannipitiya 220kV BB	BB, HV SIDE [LINE BAY + BB(HV)]		
	Description	Failure Rate, λ (f/hr)	MTTR ,r
	BBHV	0.0085731918	10.5574
	No. of Parral Lines	2	0.0000001857
	LINE BAY	LB,s	0.0158
		ISO+ES	0.0061
		CB	0.0036
		ISO	0.0061
BB(HV)	BBH	0.0085730061	10.6
	BB	0.0085730061	10.6

Pannipitiya Transformer Bay + 132kV BB	GSS [TRANSFORMER BAY + BB(LV)]		
	Description	Failure Rate, λ	MTTR ,r
	GSS	0.00858	10.55743
	No. of Parral Lines	2	0.000002296
	TRANSFORMER BAY	TB,s	0.0224
		ISO	0.0061
		CB	0.0036
		TRANFO	0.0030
		CB	0.0036
		ISO+ES	0.0061
BB(LV)	BBL	0.0085730061	10.56
	BB	0.0085730061	10.56

Pannipitiya 132kV Feeder Bay + 132kV TX Line to Rathmalana	TX LINE [FEEDER BAY + LINE]			
	Description		Failure Rate, λ	MTTR ,r
	TXL		0.003729198	7.9108
No. of Parral Lines	2	0.003729198	7.9108	
FEEDER BAY	FB,s	1.0161	15.8216	
	ISO	0.0061	3.6	
	CB	0.0036	2.1	
	ISO+ES	0.0061	3.6	
LINE	L (7km)	1.0003	16.0200	

132kV Line Bay + Rathmalana 132kV BB	BB, HV SIDE [LINE BAY + BB(HV)]			
	Description		Failure Rate, λ	MTTR ,r
	BBHV		0.0102	26.7995
No. of Parral Lines	2	0.0000001857	1.6291	
LINE BAY	LB,s	0.0158	3.2582	
	ISO+ES	0.0061	3.60	
	CB	0.0036	2.10	
	ISO	0.0061	3.60	
	BB(HV)	BBH	0.01020	26.8
	BB	0.01020	26.8	

Rathmalana 132kV Feeder Bay + 132kV Cable Line to TSS	TX LINE [FEEDER BAY + LINE]			
	Description		Failure Rate, λ	MTTR ,r
	TXL		1.016489	10.148
No. of Parral Lines	1	1.01649	10.148	
FEEDER BAY	FB,s	1.0165	10.148	
	ISO	0.0061	3.6	
	CB	0.0036	2.1	
	ISO+ES	0.0061	3.6	
LINE	L (1.6km)	1.00069	10.26	

Pannipitiya 132kV Feeder Bay + 132kV Cable Line to Dehiwal	TX LINE [FEEDER BAY + LINE]		
	Description	Failure Rate, λ	MTTR ,r
	TXL	1.0165	53.507
	No. of Parral Lines	1	
	<i>FEEDER BAY</i>	FB,s	1.0165
		ISO	0.0061
		CB	0.0036
		ISO+ES	0.0061
	<i>LINE</i>	L (9km)	1.0007
			54.3000

132kV Line Bay + Dehiwala 132kV BB	BB, HV SIDE [LINE BAY + BB(HV)]		
	Description	Failure Rate, λ	MTTR ,r
	BBHV	0.0102	26.7995
	No. of Parral Lines	2	0.0000001857
	<i>LINE BAY</i>	LB,s	0.0158
		ISO+ES	0.0061
		CB	0.0036
		ISO	0.0061
	<i>BB(HV)</i>	BBH	0.0102
		BB	0.0102
			26.8
			26.8

Dehiwala 132kV Feeder Bay + 132kV Cable Line to TSS	TX LINE [FEEDER BAY + LINE]		
	Description	Failure Rate, λ	MTTR ,r
	TXL	1.0165	10.148
	No. of Parral Lines	1	1.0165
	<i>FEEDER BAY</i>	FB,s	1.0165
		ISO	0.0061
		CB	0.0036
		ISO+ES	0.0061
	<i>LINE</i>	L(1.7km)	1.0007
			10.2567

TSS [TRANSFORMER BAY + BB(LV)+TX LINE]			
Description		Failure Rate, λ	MTTR ,r
GSS		0.000003445	8.7890
No. of Parral Lines	2	0.000003445	8.7890
TRANSFORMER BAY	TB,s	<i>0.0293</i>	17.5780
	<i>ISO+ES</i>	0.0061	3.6
	<i>CB (MV)</i>	0.0036	2.1
	<i>ISO+ES</i>	0.0061	3.6
	<i>TRANFO(132/25kV)</i>	0.0030	130.0
	<i>ISO</i>	0.0061	3.6
	<i>CB(LV)</i>	0.0027	4.0
BB(LV)	BB	0.0017	24.0
TX LINE		0.00000364	4.9637
No. of Parral Lines	2	0.00000364	4.9637
FEEDER BAY	FB,s	0.0127	9.9274
	<i>CB</i>	0.0027	4.0
	<i>ISO+ES</i>	0.0061	3.6
LINE	L	0.00388	24.0

OPTION 4 - Feed to TSS only using Rathmalana GSS					
Description	GSS, 220/132kV Pannipitiya	Cable line, 132kV	TSS, 132/25kV	TX line, 25kV	Costal Line
Failure Rate, λ	0.01715	0.0145561802	0.000003445		0.031708120
MTTR ,r	10.557	8.984	8.789		9.8351

Description	GSS, 220/132kV Pannipitiya	Cable line, 132kV			TSS, 132/25kV	TX line, 25kV	
Failure Rate, λ							
MTTR ,r							
		TX line, 132kV					
Failure Rate, λ	0.01715	0.0145562			0.000003445		
MTTR ,r	10.557	8.9843			8.7890		

Description	GSS, 220/132kV Pannipitiya	Cable line, 132kV	BB, 132kV- Dehiwal	Cable line, 132kV	TSS, 132/25kV	TX line, 25kV	
Failure Rate, λ							
MTTR ,r							
		TX line, 132kV	BB, 132kV Rathmalana	Cable line, 132kV			
Failure Rate, λ	0.01715	0.00372920	0.0086	0.002253790	0.000003445		
MTTR ,r	10.5574	7.9108	10.5574	4.7770	8.7890		

220kV Line Bay + Pannipitiya 220kV BB	BB, HV SIDE [LINE BAY + BB(HV)]			
	Description		Failure Rate, λ (f/hr)	MTTR ,r
	BBHV		0.008573	10.5574
	No. of Parral Lines	2	0.0000001857	1.6291
	LINE BAY	LB,s	0.0158	3.25823
		ISO+ES	0.0061	3.6
		CB	0.0036	2.1
		ISO	0.0061	3.6
BB(HV)	BBH	0.008573	10.6	
	BB	0.008573	10.6	

Pannipitiya Transformer Bay + 132kV BB	GSS [TRANSFORMER BAY + BB(LV)]			
	Description		Failure Rate, λ	MTTR ,r
	GSS		0.00858	10.55743
	No. of Parral Lines	2	0.000002296	10.02321
	TRANSFORMER BAY	TB,s	0.0224	20.0464
		ISO	0.0061	3.6
		CB	0.0036	2.1
		TRANFO	0.0030	130.0
		CB	0.0036	2.1
	BB(LV)	ISO+ES	0.0061	3.6
BBL		0.008573	10.56	
	BB	0.008573	10.56	

TX LINE [FEEDER BAY + LINE]				
Description		Failure Rate, λ	MTTR ,r	
Pannipitiya 132kV Feeder Bay + 132kV TX Line to Rathmalana	TXL		0.00372920	7.9108
	No. of Parral Lines	2	0.00372920	7.9108
	FEEDER BAY	FB,s	1.0161	15.8216
		<i>ISO</i>	0.0061	3.6
		<i>CB</i>	0.0036	2.1
		<i>ISO+ES</i>	0.0061	3.6
	LINE	L (7km)	1.00026	16.02002

BB, HV SIDE [LINE BAY + BB(HV)]				
Description		Failure Rate, λ	MTTR ,r	
132kV Line Bay + Rathmalana 132kV BB	BBHV		0.008573	10.55738
	No. of Parral Lines	2	0.0000001857	1.6291
	LINE BAY	LB,s	<i>0.0158</i>	3.2582
		<i>ISO+ES</i>	<i>0.0061</i>	3.60
		<i>CB</i>	<i>0.0036</i>	2.1
		<i>ISO</i>	<i>0.0061</i>	3.60
	BB(HV)	BBH	0.008573	10.6
		<i>BB</i>	0.008573	10.6

TX LINE [FEEDER BAY + LINE]				
Description		Failure Rate, λ	MTTR ,r	
Rathmalana 132kV Feeder Bay + 132kV Cable Line to TSS	TXL		0.002253790	4.777
	No. of Parral Lines	2	0.002253790	4.7770
	FEEDER BAY	FB,s	1.0165	9.554
		<i>ISO</i>	0.0061	3.6
		<i>CB</i>	0.0036	2.1
		<i>ISO+ES</i>	0.0061	3.6
	LINE	L (1.6km)	1.00069	9.65

TSS [TRANSFORMER BAY + BB(LV)+TX LINE]				
Description		Failure Rate, λ	MTTR ,r	
TSS Transformer Bay + 25kV BB TSS + 25kV Feeder Bay + 25kV Cable Line	GSS		0.000003445	8.7890
	No. of Parral Lines	2	0.000003445	8.7890
	TRANSFORMER BAY	TB,s	<i>0.02930</i>	17.5780
		<i>ISO+ES</i>	0.0061	3.6
		<i>CB (MV)</i>	0.0036	2.1
		<i>ISO+ES</i>	0.0061	3.6
		<i>TRANFO(132/25kV)</i>	0.0030	130.0
		<i>ISO</i>	0.0061	3.6
		<i>CB(LV)</i>	0.0027	4.0
	BB(LV)	BB	0.0017	24.0
	TX LINE		0.000000364	4.9637
	No. of Parral Lines	2	0.000000364	4.9637
	FEEDER BAY	FB,s	0.0127	9.9274
		<i>CB</i>	0.0027	4.0
		<i>ISO+ES</i>	0.0061	3.6
LINE	L	0.00388	24.0	

OPTION 5 - Feed to TSS only using Dehiwala GSS					
Description	GSS, 220/132kV Pannipitiya	Cable line, 132kV	TSS, 132/25kV	TX line, 25kV	Costal Line
Failure Rate, λ	0.01715	0.02311468	0.000003445		0.04027
MTTR ,r	10.557	22.50	8.789		17.41

Description	GSS, 220/132kV Pannipitiya	Cable line, 132kV		TSS, 132/25kV	TX line, 25kV
Failure Rate, λ		0.02311468			
MTTR ,r		22.5009			
		TX line, 132kV			
Failure Rate, λ	0.01715			0.000003445	
MTTR ,r	10.557			8.7890	

Description	GSS, 220/132kV Pannipitiya	Cable line, 132kV	BB, 132kV- Dehiwal	Cable line, 132kV	TSS, 132/25kV	TX line, 25kV
Failure Rate, λ		0.010520586	0.0102	0.002393905		
MTTR ,r		22.2986	26.7995	5.0739		
		TX line, 132kV	BB, 132kV Rathmalana	Cable line, 132kV		
Failure Rate, λ	0.01715				0.000003445	
MTTR ,r	10.5574				8.7890	

220kV Line Bay + Pannipitiya 220kV BB	BB, HV SIDE [LINE BAY + BB(HV)]			
	Description		Failure Rate, λ (f/hr)	MTTR ,r
	BBHV		0.008573	10.5574
	No. of Parral Lines	2	0.0000001857	1.6291
	LINE BAY	LB,s	0.0158	3.25823
		ISO+ES	0.0061	3.6
		CB	0.0036	2.1
		ISO	0.0061	3.6
	BB(HV)	BBH	0.008573	10.6
		BB	0.008573	10.557576

Pannipitiya Transformer Bay + 132kV BB	GSS [TRANSFORMER BAY + BB(LV)]			
	Description		Failure Rate, λ (f/hr)	MTTR ,r
	GSS		0.00858	10.55743
	No. of Parral Lines	2	0.000002296	10.02321
	TRANSFORMER BAY	TB,s	0.0224	20.0464
		ISO	0.0061	3.6
		CB	0.0036	2.1
		TRANFO	0.0030	130.0
		CB	0.0036	2.1
		ISO+ES	0.0061	3.6
BB(LV)	BBL	0.008573	10.56	
	BB	0.008573	10.56	

Pannipitiya 132kV Feeder Bay + 132kV Cable Line to Dehiwal	TX LINE [FEEDER BAY + LINE]		
	Description	Failure Rate, λ (f/hr)	MTTR ,r
	TXL	0.010520586	22.2986
	No. of Parral Lines	2	0.010520586
	<i>FEEDER BAY</i>	FB,s	1.0165
		ISO	0.0061
		CB	0.0036
		ISO+ES	0.0061
	<i>LINE</i>	L	1.00069
			45.25000

132kV Line Bay + Dehiwala 132kV BB	BB, HV SIDE [LINE BAY + BB(HV)]		
	Description	Failure Rate, λ (f/hr)	MTTR ,r
	BBHV	0.010200	26.7995
	No. of Parral Lines	2	0.0000001857
	<i>LINE BAY</i>	LB,s	0.0158
		ISO+ES	0.0061
		CB	0.0036
		ISO	0.0061
	<i>BB(HV)</i>	BBH	0.010200
		BB	0.010200
			26.8

Dehiwala 132kV Feeder Bay + 132kV Cable Line to TSS	TX LINE [FEEDER BAY + LINE]		
	Description	Failure Rate, λ (f/hr)	MTTR ,r
	TXL	0.002393905	5.074
	No. of Parral Lines	2	0.002393905
	<i>FEEDER BAY</i>	FB,s	1.01649
		ISO	0.0061
		CB	0.0036
		ISO+ES	0.0061
	<i>LINE</i>	L (1.7km)	1.00069
			10.26

TSS [TRANSFORMER BAY + BB(LV)+TX LINE]				
	Description		Failure Rate, λ(f/hr)	MTTR ,r
	TSS Transformer Bay + 25kV BB TSS + 25kV Feeder Bay + 25kV Cable Line	GSS		0.000003445
No. of Parral Lines		2	0.000003445	8.7890
TRANSFORMER BAY		TB,s	<i>0.02930</i>	17.5780
		<i>ISO+ES</i>	0.0061	3.6
		<i>CB (MV)</i>	0.0036	2.1
		<i>ISO+ES</i>	0.0061	3.6
		<i>TRANFO(132/25kV)</i>	0.0030	130.0
		<i>ISO</i>	0.0061	3.6
		<i>CB(LV)</i>	0.0027	4.0
BB(LV)		BB	0.0017	24.0
TX LINE			0.000000364	4.9637
No. of Parral Lines		2	0.000000364	4.9637
FEEDER BAY		FB,s	0.0127	9.9274
		<i>CB</i>	0.0027	4.0
		<i>ISO+ES</i>	0.0061	3.6
LINE		L	0.00388	24.0

Costal Line Feeding Options from Schematic Diagram of the 2022 Transmission System

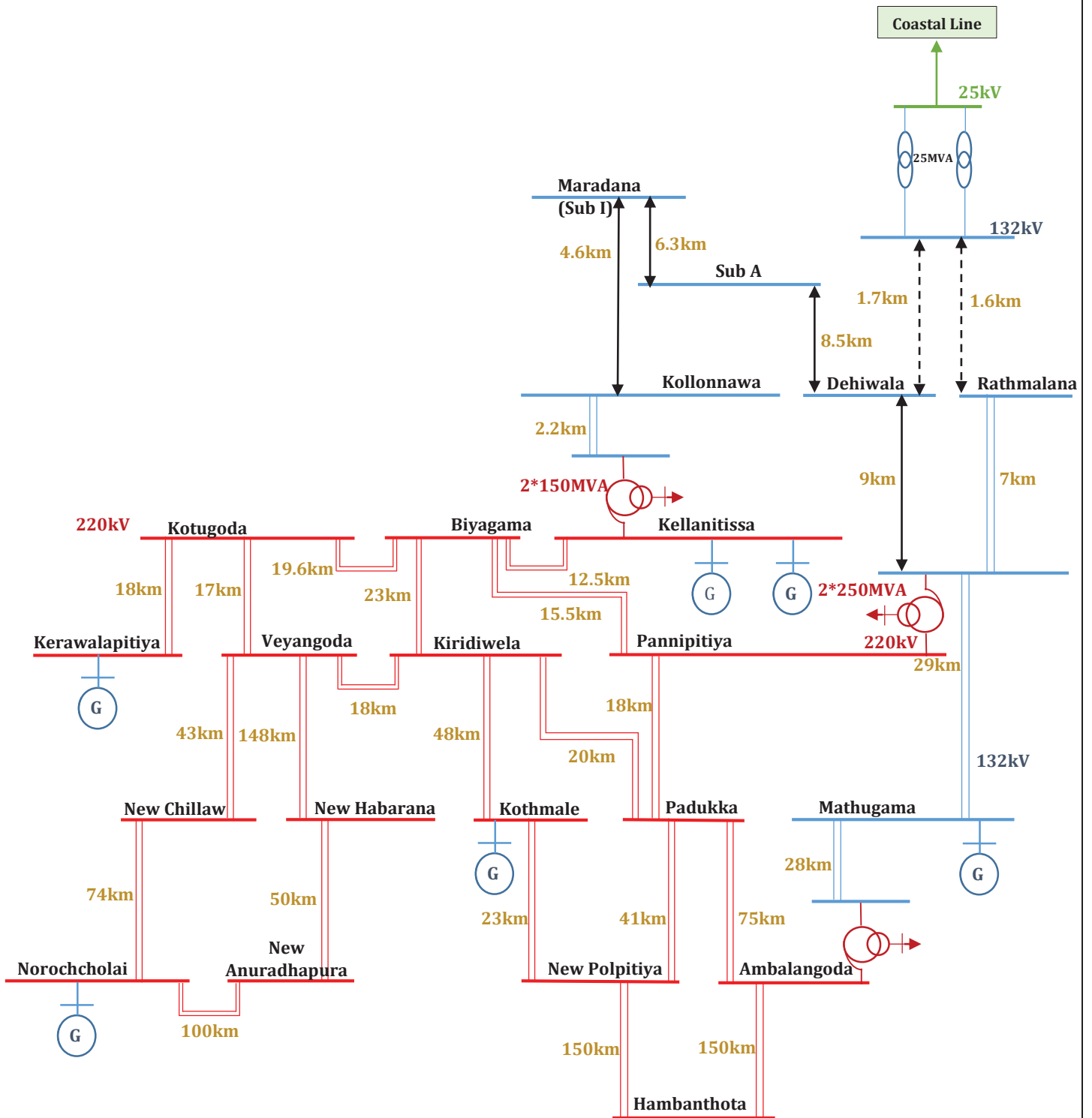

ANNEX J - RELIABILITY INDICES EVALUATION OF MAIN & PUTTALAM LINE FEEDING OPTION SIX, SEVEN AND EIGHT

Main Line & Puttalam Line			
Option	Availability	Interruption Duration (min/yr)	Reliability
OPTION 6	0.9999513	25.57	0.97585778
OPTION 7	0.9999596	21.21	0.98370136
OPTION 8	0.9999879	6.34	0.988812448

Option 6 - Feed to TSS using existing Network			
Description	Parallel Feeding to TSS BB	TSS, 132/25kV	Costal Line
Failure Rate, λ	0.02443	0.000003445	0.024438420
MTTR, r	17.441	8.789	17.4401

Description	GSS, 220/132kV - Biyagama	TX line, 132kV	BB, 132kV Sapugaskanda	TX line, 132kV	BB, 132kV - Kelaniya	TX line, 132kV	Cable line, 132kV	TSS, 132/25kV	BB, 132kV- Aniyagakanda	TX line, 25kV	Failure Rate, λ	MTTR, r
											0.0057	8.789
Description	GSS, 220/132kV - Kotugoda	TX line, 132kV									0.01878	19.1366
		TX line, 132kV									0.000003445	8.7890

Description	GSS, 220/132kV - Biyagama	TX line, 132kV	BB, 132kV Sapugaskanda	TX line, 132kV	BB, 132kV - Kelaniya	TX line, 132kV	Cable line, 132kV	TSS, 132/25kV	BB, 132kV- Aniyagakanda	TX line, 25kV	Failure Rate, λ	MTTR, r
											1.0210	8.7890
Description	GSS, 220/132kV - Kotugoda	TX line, 132kV									0.01878	19.1366
		TX line, 132kV									0.000003445	8.7890

Description	GSS, 220/132kV - Biyagama	TX line, 132kV	BB, 132kV Sapugaskanda	TX line, 132kV	TX line, 132kV	TX line, 132kV	BB, 132kV- Kelaniya	BB, 132kV- Aniyagakanda	Cable line, 132kV	TSS, 132/25kV	TX line, 25kV
Failure Rate, λ							1.0246	0.01878		0.000003445	
MTTR, r			5.9451				24.7141	19.1366		8.7890	
Description	GSS, 220/132kV - Kotugoda	TX line, 132kV									
Failure Rate, λ								1.0210			
MTTR, r								22.6054			

Description	GSS, 220/132kV - Kelanitissa	TX line, 132kV	BB, 132kV Kolonnawa	TX line, 132kV	TX line, 132kV	BB, 132kV- Kelaniya	BB, 132kV- Aniyagakanda	Cable line, 132kV	TSS, 132/25kV	TX line, 25kV	
											Failure Rate, λ
Failure Rate, λ											
MTTR, r			0.0304								
			9.887								
Description	GSS, 220/132kV - Biyagama	TX line, 132kV									
Failure Rate, λ											
MTTR, r			0.0320								
			14.912								
Description	GSS, 220/132kV - Kotugoda	TX line, 132kV									
Failure Rate, λ	0.0171							0.01878		0.000003445	
MTTR, r	10.558							19.14		8.7890	

Description	GSS, 220/132kV - Kelanitissa	TX line, 132kV	BB, 132kV Kolonnawa	TX line, 132kV
Failure Rate, λ	0.017148494	0.00118	0.00857	0.00352
MTTR ,r	10.5574	2.5036	10.5576	7.4602

Description	GSS, 220/132kV - Biyagama	TX line, 132kV	BB, 132kV	TX line, 132kV
Failure Rate, λ	0.017148309	0.00224	0.01020	0.00245
MTTR ,r	10.5575	4.7566	26.7995	5.2072

Description	GSS, 220/132kV - Kotugoda
Failure Rate, λ	
MTTR ,r	

BB, 132kV- Kelaniya		TX line, 132kV	BB, 132kV- Aniyagakanda	Cable line, 132kV	TSS, 132/25kV	TX line, 25kV
Failure Rate, λ	0.0086	1.0161				
MTTR ,r	10.5576	24.8335				
GSS, 220/132kV - Kotugoda		TX line, 132kV				
Failure Rate, λ	0.017148309	1.00386				
MTTR ,r	10.5575	22.8112				
		0.01569	0.00309	0.000003445		
		21.6174	6.5588	8.7890		

OPTION 7 - Line in and Out connection from Kotugoda - Kelaniya Line				
Description	Parallel Feeding to TSS BB	TSS, 132/25kV	TX line, 25kV	Costal Line
Failure Rate, λ	0.01643	0.000003445		0.01643
MTTR ,r	21.514	8.789		21.5114

Description	GSS, 220/132kV - Biyagama	TX line, 132kV	BB, 132kV Sapugaskanda	TX line, 132kV	BB, 132kV- Kelaniya	TX line, 132kV	BB, 132kV- TSS	TSS, 132/25kV	TX line, 25kV	
	GSS, 220/132kV - Kelanitissa	TX line, 132kV	BB, 132kV Kolonnawa	TX line, 132kV						
Description	GSS, 220/132kV - Kotugoda	TX line, 132kV								
	Failure Rate, λ	0.0062						0.01020	0.000003445	
MTTR ,r	12.8594						26.7995	8.7890		

Description	GSS, 220/132kV - Biyagama	TX line, 132kV	BB, 132kV Sapugaskanda	TX line, 132kV	BB, 132kV- Kelaniya	TX line, 132kV	BB, 132kV- TSS	TSS, 132/25kV	TX line, 25kV	
	GSS, 220/132kV - Kelanitissa	TX line, 132kV	BB, 132kV Kolonnawa	TX line, 132kV						
Description	GSS, 220/132kV - Kotugoda	TX line, 132kV								
	Failure Rate, λ	1.0332						0.01020	0.000003445	
MTTR ,r	24.5966						26.7995	8.7890		

Description	A				E	
	GSS, 220/132kV - Biyagama	TX line, 132kV	BB, 132kV Sapugaskanda	TX line, 132kV	BB, 132kV- Kelaniya	TX line, 132kV
	GSS, 220/132kV - Kelanitissa	TX line, 132kV	BB, 132kV Kolonnawa	TX line, 132kV		
Failure Rate, λ	0.000002759					
MTTR ,r	5.9451					

Description	B		D		F	
	GSS, 220/132kV - Kotugoda	TX line, 132kV	BB, 132kV- TSS	TSS, 132/25kV	TX line, 25kV	
	GSS, 220/132kV - Kotugoda	TX line, 132kV				
Failure Rate, λ	0.01715	1.0161	0.01020	0.000003445		
MTTR ,r	10.5575	24.8335	26.7995	8.7890		

Description	BB, 132kV- Kelaniya		TX line, 132kV	
	GSS, 220/132kV - Kelanitissa	TX line, 132kV	BB, 132kV Kolonnawa	TX line, 132kV
	GSS, 220/132kV - Biyagama	TX line, 132kV	BB, 132kV	TX line, 132kV
Failure Rate, λ	0.0304	0.0320	0.0320	
MTTR ,r	9.887	14.912		

Description	BB, 132kV- Kelaniya		TX line, 132kV	
	GSS, 220/132kV - Kotugoda	TX line, 132kV	BB, 132kV- TSS	TSS, 132/25kV
	GSS, 220/132kV - Kotugoda	TX line, 132kV		
Failure Rate, λ	0.0171	1.0161	0.01020	0.000003445
MTTR ,r	10.558	24.8335	26.79954	8.7890

Option 8 - Feed to TSS using existing Network			
Description	Parallel Feeding to TSS BB	TSS, 132/25kV	Costal Line
Failure Rate, λ	0.011247	0.000003445	0.01125
MTTR, r	9.395	8.789	9.3948

Description	GSS, 220/132kV - Biyagama	TX line, 132kV	BB, 132kV Sapugaskanda	TX line, 132kV	BB, 132kV - Kelaniya	TX line, 132kV	TSS, 132/25kV	TX line, 25kV
		GSS, 220/132kV - Kelanitissa	TX line, 132kV	BB, 132kV Kolonnawa	TX line, 132kV			
	GSS, 220/132kV - Kotugoda	TX line, 132kV						
Failure Rate, λ	0.000000016							
MTTR, r	5.2209							
						0.0112	0.000003445	
						9.3950	8.7890	

Description	A				E		F
	GSS, 220/132kV - Biyagama	TX line, 132kV	BB, 132kV Sapugaskanda	TX line, 132kV	BB, 132kV - Kelaniya	TX line, 132kV	TSS, 132/25kV
	GSS, 220/132kV - Kelanitissa	TX line, 132kV	BB, 132kV Kolonnawa	TX line, 132kV			
Failure Rate, λ	0.000002759						
MTTR, r	5.9451						
	TX line, 132kV						
	1.0161				0.011247		0.000003445
	42.8574				9.3950		8.7890

Description	GSS, 220/132kV - Kelanitissa	TX line, 132kV	BB, 132kV Kolonnawa	TX line, 132kV
Failure Rate, λ			0.0304	
MTTR ,r			9.887	
BB, 132kV - Kelaniya				
Description	GSS, 220/132kV - Biyagama	TX line, 132kV	BB, 132kV	TX line, 132kV
Failure Rate, λ			0.0320	
MTTR ,r			14.912	
Description	GSS, 220/132kV - Kotugoda	TX line, 132kV	TX line, 132kV	TX line, 132kV
Failure Rate, λ	0.0171		1.0161	
MTTR ,r	10.558		42.8574	
TSS, 132/25kV				
				0.0112
				9.3950
				0.000003445
				8.7890

Description	GSS, 220/132kV - Kelanitissa	TX line, 132kV	BB, 132kV Kolonnawa	TX line, 132kV
Failure Rate, λ	0.017148494	0.00118	0.00857	0.00352
MTTR ,r	10.5574	2.5036	10.5576	7.4602
BB, 132kV - Kelaniya				
Description	GSS, 220/132kV - Biyagama	TX line, 132kV	BB, 132kV	TX line, 132kV
Failure Rate, λ	0.017148309	0.00224	0.01020	0.00245
MTTR ,r	10.5575	4.7566	26.7995	5.2072
Description	GSS, 220/132kV - Kotugoda	TX line, 132kV	TX line, 132kV	TX line, 132kV
Failure Rate, λ	0.017148309		1.0161	
MTTR ,r	10.5575		42.8574	
TSS, 132/25kV				
				0.0086
				10.5576
				0.002674
				5.6679
				0.00000
				8.7890

ANNEX K - MONTE CARLO SIMULAION RESULT OF KV, COASTAL AND MAIN & PUTTALA LINE

DESCRIPTION	NUMBER OF TRAILS	KV LINE	COASTAL LINE	MAIN & PUTTALAM LINE
SIMULAITON RESULT	1000	0.981188	0.980198	0.988000
	2000	0.981095	0.977612	0.985500
	3000	0.983056	0.974419	0.984000
	4000	0.984040	0.973566	0.982250
	5000	0.984232	0.972056	0.982600
	6000	0.984859	0.972546	0.983000
	7000	0.984023	0.973181	0.983000
	8000	0.984644	0.973783	0.982125
	9000	0.983796	0.973585	0.982556
	10000	0.983317	0.973626	0.983100
	11000	0.983288	0.974569	0.983455
	12000	0.982598	0.974854	0.983917
	13000	0.982706	0.974712	0.984077
	14000	0.982941	0.974518	0.984143
	15000	0.982811	0.974017	0.984267
	16000	0.983011	0.974204	0.983938
	17000	0.983245	0.974192	0.983882
	18000	0.982898	0.974459	0.983778
	19000	0.982746	0.974224	0.983895
	20000	0.982559	0.973913	0.983950
	21000	0.982389	0.973917	0.984286
	22000	0.982235	0.973921	0.983955
	23000	0.982312	0.973577	0.983870
	24000	0.982382	0.973969	0.984208
	25000	0.982407	0.973930	0.984280
	26000	0.982391	0.974010	0.984423
	27000	0.982525	0.974084	0.984185
	28000	0.982935	0.974045	0.984321
	29000	0.983109	0.973906	0.984207
	30000	0.983072	0.974419	0.984167
	31000	0.983231	0.974105	0.984258
	32000	0.983162	0.974321	0.984250
	33000	0.983248	0.974371	0.984182
34000	0.983299	0.974684	0.984324	
35000	0.983348	0.974550	0.984257	
36000	0.983227	0.974535	0.984194	
37000	0.983221	0.974601	0.984162	
38000	0.983399	0.974349	0.984237	
39000	0.983235	0.974237	0.984205	
40000	0.983279	0.974156	0.984300	
41000	0.983224	0.974275	0.984439	
42000	0.983123	0.974458	0.984381	
43000	0.983074	0.974448	0.984372	
44000	0.983186	0.974551	0.984250	
45000	0.983093	0.974539	0.984289	
46000	0.983134	0.974419	0.984109	
47000	0.983216	0.974218	0.984128	
48000	0.983316	0.974276	0.983979	
49000	0.983289	0.974209	0.984020	
50000	0.983020	0.973980	0.984000	
ANALYTICAL RESULT		0.982994	0.973097	0.983701
DIFFERENCE		0.000026	0.000883	0.000299