

**IMPROVING PROPERTIES OF CEMENT BASED SKIM
COAT THROUGH CONTROLLING WATER
ABSORPTION USING A VINYL ACETATE-ETHYLENE
COPOLYMER**

Sunanda Wickramanayaka

158516X

Degree of Master of Science

Department of Chemical and Process Engineering

University of Moratuwa

Sri Lanka

February 2020

**IMPROVING PROPERTIES OF CEMENT BASED SKIM
COAT THROUGH CONTROLLING WATER
ABSORPTION USING A VINYL ACETATE-ETHYLENE
COPOLYMER**

Sunanda Wickramanayaka

158516X

This thesis submitted in partial fulfillment of the requirements for the
degree Master of Science in Polymer Technology

Department of Chemical and Process Engineering

University of Moratuwa
Sri Lanka

February 2020

DECLARATION

I declare that this is my work and this thesis/dissertation does not incorporate without acknowledgment any material previously submitted for a Degree or Diploma in any other University or institute of higher learning and to the best of my knowledge and belief it does not contain any material previously published or written by another person except where the acknowledgment is made in the text.

Also, I hereby grant to the University of Moratuwa the non-exclusive right to reproduce and distribute my thesis/dissertation, in whole or in part in print, electronic or other media. I retain the right to use this content in whole or part in future works (such as articles or books).

Signature:..... Date:.....

The above candidate has researched for the Master's Dissertation under my supervision.

Name of the supervisor: Dr.M.A.B.Prasantha

Signature of the supervisor: Date:

Name of the co-supervisor: Prof.Jagath Premachandra

Signature of the co-supervisor: Date:

ABSTRACT

Improving properties of cement-based skim coat through controlling water absorption using a Vinyl Acetate-Ethylene copolymer

This study aims to describe and complement the existing knowledge on the effect of re-dispersible polymer powder (RDP) on water absorption (capillary and surface), application and mechanical properties of cement-based skim coat. The skim coat is a mixture of cement (binder), dolomite powder (filler), cellulose thickener (water retention agent) and re-dispersible polymer powder as a performance-enhancing additive. In this study, commercially available white cement with CEM 42.5 N strength class, Methyl Hydroxyl Ethyl Cellulose (MHEC), Vinyl acetate-ethylene copolymer (RDP) and locally available dolomite powder with particle size below 150 microns have been used. The dosage of RDP was changed from 0% to 2.5 % by the total weight of the formulations.

Furthermore, to evaluate the effect of MHEC on the application and final properties of the cement-based skim coat, the MHEC amount was changed from 0 % to 0.4% by the total weight of the formulation. Three white cement-based skim coat products from the market were used to compare the effect of the RDP addition.

Water to skim coat mixing ratio was kept constant at 35:100 throughout the experiment. It was found that RDP improved the mechanical properties of the dried skim coat and application properties of the fresh skim coat paste. Adhesive strength and flexural strength were increased with RDP dosage while compressive strength had an optimum RDP level between 1%-1.5%. Open time and setting times were positively affected by RDP dosage and optimum flow properties were achieved at 1.5% of RDP. Both capillary and surface water absorption were reduced with the addition of RDP and reached the lowest at 1.5 % wt. All the application and final performance of the skim coat were improved from 0% to 0.4% with the addition of MHEC.

Keywords – *Skim coat, Cellulose thickener, Re-dispersible polymer powder.*

DEDICATION

To

MY FAMILY MEMBERS

THIS BOOK

Is

AFFECTIONATELY DEDICATED

ACKNOWLEDGMENT

First of all, I would like to convey my sincere gratitude to Dr.M.A.B.Prasantha, Department of Chemistry, University of Jayawardanapura, Sri Lanka, for the guidance provided to me throughout the research. I appreciate the support he gave me to complete this task effectively by sharing his knowledge and previous research experiences. Those points were very helpful when I was moving to another direction. His questioning enhances my thinking ability. Al I extend my gratitude to my second supervisor Prof. B. A. J. K. Premachandra for the instructions given during the research and as a course coordinator of MSc in Polymer Technology, University of Moratuwa, Sri Lanka in 2015 Batch. He was guiding our batch being flexible at all the time to complete the MSc.

My special thanks are towards Mr.Viraj Bandara for sharing the knowledge as a Chemical engineer. Again I offer my thanks to Maha Chemicals Sri Lanka (Pvt) Ltd for supporting me to test samples for Compressive, Flexural and Adhesion strength, Setting time and Flow properties. Then I thank technicians in my workplace St.Anthony's Coating (Pvt) Ltd -Research and Development section for supporting in sample testing.

And I thank any other person whose name is not mentioned in his/her effort gave me the best.

CONTENTS

Declaration	iii
Abstract	iv
Dedication	v
Acknowledgment	vi
List of Figures	x
List of Tables	xii
1 Chapter 1: Research Introduction	1
1.1 Background of the study	1
1.1.1 Introduction to skim coat and Skim Coating.....	1
1.2 Problem Identification	2
1.3 Research Objectives.....	4
1.4 The rationale of the study.....	4
1.5 Significance of the Research	5
2 Chapter 2: Literature Review	6
2.1 Details of available skim coat brands in the Sri Lankan market	6
2.2 Available compounds similar to cement-based skim coat	7
2.2.1 Lime as a construction material.....	8
2.2.2 Gypsum as a construction material.....	8
2.2.3 Joint Compound/Acrylic based Wall Putty.....	9
2.3 Composition of a White Cement based skim coat.....	10
2.3.1 White Cement.....	10
2.3.1.1 Hydration of Portland Cement	13
2.3.2 Cellulose Thickeners in Skim coat	16
2.3.3 Dolomite Powder.....	17

2.3.4	Re-dispersible Polymer Powder (RDP)	17
2.4	What is water-proofing and importance in the decorative industry	19
3	Chapter 3: Experimental Methodology	20
3.1	Research Plan	20
3.2	Materials.....	20
3.2.1	Trial set 01.....	20
3.2.2	Trial set 02.....	20
3.2.3	Trial Set 03	21
3.3	Method	21
3.3.1	Investigation of MHEC on a cement-based skim coat.	21
3.3.2	Design formulations to investigate the effect of RDP percentage	21
3.3.3	Method to compare the properties with optimum sample	22
3.3.4	Skim coat preparation methods	22
3.3.4.1	Dry skim coat powder preparation	22
3.3.4.2	Wet sample preparation	22
3.3.5	Three samples set testing methods	22
3.3.5.1	Determination of Bulk Density of dry skim coat powder.....	23
3.3.5.2	Determination of Bulk Density of fresh skim coat paste.....	23
3.3.5.3	Determination of Open time of fresh skim coat paste	24
3.3.5.4	Determination of setting time of fresh skim coat paste	24
3.3.5.5	Determination of flow properties of fresh skim coat paste.....	26
3.3.5.6	Determination of flexural and compressive strength.....	27
3.3.5.7	Determination of Adhesive Strength	30
3.3.5.8	Determination of Capillary Water Absorption.....	31
3.3.5.9	Determination of surface Water Absorption	31
3.3.5.10	Determination of surface hardness	32

4	Chapter 4: Results and Discussion	33
4.1	Test results-Bulk density of dry skim coat powder	33
4.1.1	Sample set 01.....	34
4.1.2	Sample set 02.....	34
4.1.3	Sample set 03.....	34
4.2	Test results-Bulk density of fresh skim coat paste	35
4.2.1	Sample set 01.....	36
4.2.2	Sample set 02.....	36
4.2.3	Sample set 03.....	36
4.3	Test results-Open time of fresh skim coat paste.....	37
4.3.1	Sample set 01.....	38
4.3.2	Sample set 02.....	38
4.3.3	Sample set 03.....	38
4.4	Test results-Setting times of fresh skim coat paste.....	39
4.4.1	Sample set 01.....	40
4.4.2	Sample set 02.....	40
4.4.3	Sample set 03.....	40
4.5	Test results-Flow properties of fresh skim coat paste.....	40
4.5.1	Sample set 01.....	42
4.5.2	Sample set 02.....	42
4.5.3	Sample set 03.....	42
4.6	Flexural and compressive strength of the hardened skim coat.....	43
4.6.1	Sample set 01.....	44
4.6.2	Sample set 02.....	44
4.6.3	Sample set 03.....	44
4.7	Adhesive Strength of Hardened skim coat layer	45

4.7.1	Sample set 01.....	46
4.7.2	Sample set 02.....	46
4.7.3	Sample set 03.....	46
4.8	Capillary Water Absorption of Hardened skim coat paste	46
4.8.1	Sample set 01.....	47
4.8.2	Sample set 02.....	48
4.8.3	Sample set 03.....	48
4.9	Surface water absorption of the dry skim coat layer	48
4.9.1	Sample set 01.....	49
4.9.2	Sample set 02.....	49
4.9.3	Sample set 03.....	50
4.10	Pencil Hardness test results	50
4.10.1	Sample set 01.....	51
4.10.2	Sample set 02.....	51
4.10.3	Sample set 03.....	52
4.11	Cost Analysis	52
5	Chapter 5: Conclusions and Recommendations	54
5.1	Conclusions	54
5.2	Recommendations.....	54
	Bibliography.....	55

LIST OF FIGURES

Figure 1.1: Cross-section of a wall with the skim coat layer	2
Figure 1.2: Damage surface due to Efflorescence	4
Figure 2.1: Joint compound application using a putty knife	9
Figure 2.2: Cement manufacturing process	11
Figure 2.3: Pores in calcium silicate through different stages of hydration	15
Figure 2.4: Structure of MHEC.....	16
Figure 2.5: Structure of HPMC	16
Figure 3.1: Determination of the open time of fresh skim coat paste	24
Figure 3.2: Vicat needle apparatus.....	25
Figure 3.3: Dimensions of Vicat needle apparatus	26
Figure 3.4: Flow table	27
Figure 3.5 Dimensions of a flow table	27
Figure 3.6: Universal Testing machine with skim coat cube of flexural strength test....	29
Figure 3.7: Test machine with skim coat cube for Compressive strength test	29
Figure 3.8: The scheme of the pull-off method (a) a view of the testing device (b).	30
Figure 3.9: Capillary water absorption test- diagram	31
Figure 3.10 : Pencil hardness tester with a skim coated panel.....	32
Figure 4.1: Bulk density of skim coat samples	33
Figure 4.2: Bulk density of fresh skim coat paste.....	35
Figure 4.3: Open time of fresh skim coat pastes.....	37
Figure 4.4: Setting times of fresh skim coat paste	39
Figure 4.5: Flow properties of fresh skim coat paste	41
Figure 4.6: Flexural and compressive strength of the hardened skim coat	43
Figure 4.7: Adhesive Strength of dried skim coat	45
Figure 4.8 Capillary Water Absorption after 900 minutes	47
Figure 4.9: Surface Water Absorption of hardened skim coat paste.....	49
Figure 4.10: Surface hardness of hardened skim coat layer	51

LIST OF TABLES

Table 2.1: Details of the market research of Skim Coat	6
Table 2.2: Basic formulation of gypsum base skim coat	7
Table 2.3: Typical formulation of Latex powder base smoothing compound	7
Table 2.4: Typical formulation of Acrylic base wall putty/Joint compound	8
Table 2.5 :A typical formulation of cement base skim coat	10
Table 2.6 : Specification of White cement	12
Table 2.7: Composition of OPC with chemical composition and weight percent.....	14
Table 3.1: Formulations of tested samples	21
Table 3.2: Formulations of tested samples	21
Table 3.3: Order of Hardness of pencil kit	32
Table 4.1: Bulk density of dry skim coat powder test results	33
Table 4.2 Bulk density of fresh skim coat paste test results	35
Table.4.3 Open times of fresh skim coat paste	37
Table.4.4 Setting times fresh skim coat paste	39
Table.4.5 Flow properties of fresh skim coat paste	41
Table 4.6: Flexural and compressive strength of the hardened skim coat	43
Table 4.7: Adhesive Strength of Hardened of the dry skim coat layer	45
Table 4.8: Capillary Water Absorption of hardened skim coat paste	46
Table 4.9: Surface water absorption of the dry skim coat layer	48
Table.4.10 Surface hardness of hardened skim coat layer	50
Table 4.11 : Raw material cost for one square feet (sq.ft) of Skim coat product	52

List of Abbreviations

ASTM	American Society for Testing and Materials
RDP	Re-dispersible polymer
HPMC	Hydroxy Propyl Methyl Cellulose
MHEC	Methyl Hydroxy Ethyl Cellulose
CE	Cellulose Ether
BS	British Standard
WOPC	White Ordinary Portland Cement
XRF	X-ray fluorescence
UV-VIS	Ultraviolet and visible absorption
Sqft	square foot

CHAPTER 1:

RESEARCH INTRODUCTION

1.1 Background of the study

1.1.1 Introduction to skim coat and Skim Coating

Skim Coat is a low cost, premixed, water-based, and low-shrinkage finishing, surface leveling compound that provides a smooth finish to be received expensive top coating [1]. Skim Coat is ideal for rectification, facing-up and general preparation of substrates to be top-coated with paints. It is suitable for patching, filling cracks, holes, blowholes, surface imperfections, and irregularities, skimming and general enhancement of the surfaces. In Sri Lanka most of the skim coat suitable for interior application only, but some of the manufacturers have developed cement-based skim coat products for both interior and exterior applications. Off-form concrete, cement plastered wall, concrete surfaces, cement blocks, cement fiber ceiling sheet, and gypsum board are suitable surfaces for receiving the skim coat.

There are three types of skimming compounds in the market that could be used for the level the cement plastered or concrete surfaces before paint application. The first one is hydrated lime. It is the most primitive product and comparatively very difficult in application. In the present day, it has less popular among customers and painters. Usually hydrated lime is applying just after the cement plastering and before it gets dried. The second one is powder form cement-based skim coat or gypsum-based products. The third one is ready to use the acrylic-based paste form wall putty/joint compound [2]. These are the main products available in the market with higher preferences. In the Sri Lankan market, cement-based skim coat dry powder is used over the gypsum-based skim coat as a skimming compound. Further, cement-based skim coats are used in the construction industry mainly due to cost-effectiveness over paste form ready to use wall putty/joint compound. Acrylic-based ready to use paste form wall putty is most preferred by the painters over cement-based skim coat due to ease of application. But the main disadvantage with the acrylic-based ready to use wall putty/joint compound is a higher price and poor water resistance, but it has good workability and smooth finish. On the other hand, cement-based skim coat cheaper but painters are finding workability or applications problems as compared to ready to use wall putty/joint compound. Unlike acrylic-based ready to use wall putty/joint compound, the cement-based skim coat should be mixed with water using a mixing machine and apply before getting set. The fineness of the filler, water retention ability, and

cement percentage mainly affect the quality variation of the skim coat. When considering typical skim coat formulation, cement, filler, cellulose thickeners and polymer are the main ingredients. Cement is used as a bonding agent and Calcium Magnesium carbonate powder (Dolomite powder) is used as a filler, Cellulose thickener (mainly HPMC or MHEC) use for water retention and workability enhancement, while re-dispersible polymer powder is used to improve the consistency, mechanical strengths, and reduce water absorption properties [3] [4] [5]. In present days white cement-based skim coat is more popular in the market than hydrated lime and acrylic based ready to use wall putty/joint compound. Therefore cement-based skim coat was selected for the improvement of the properties through controlling water absorption using RDP in the present study. Table 2.3.1 shows a typical composition of the ingredients in the cement-based skim coat. Figure 1.1 shows the order of two layers over the brick wall [6].

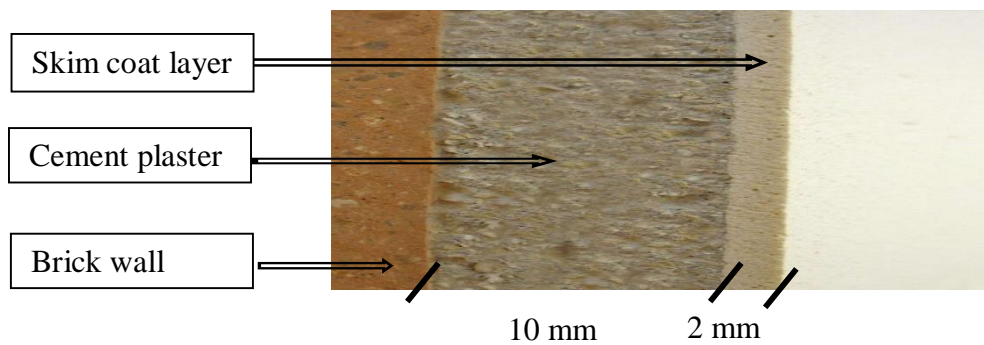

Figure 1.1: Cross-section of a wall with the skim coat layer

1.2 Problem Identification

According to the comments from skim coat manufacturers, customers and painters, two types of problems were identified. Problems on application and problems on performance were the main problems identified. The problems on applications are mainly associated with difficulty in preparing the paste by mixing the dry powder with water, working difficulties, quick setting, low open time, and sanding difficulties. Generally, water content to be mixed with the skim coat is 35 – 40 % of the total weight of the skim coat. The prepared mixture should be compatible with target surfaces to be skim coated and paste should be easily spreadable with the help of a relevant tool such as scrapper, putty handle or trowel. If these factors can be achieved, the mixture has a good workability or application properties [3]. Generally prepared to skim coat paste using a good quality cement-based skim coat should be usable for 2 or more hours. Working time and the amount of skim coat to be prepared by mixing with water are depending on the size of the surface area to be finished and the available number of painters. If

the surface area and painters are not limited, usually painters mix about 20 kg bag at a time using an electric putty mixer. Further, in large scale construction site they prefer to have a longer open time or working time since they can mix large amounts of skim coat powder. In the Sri Lankan market, most of the skim coat products are having in low open time and set within 20-40 minutes or before one hour. Once set the prepared paste it is difficult to spread on the surface to get the smooth finish and required final properties. When the mixed skim coat paste has poor water retention ability [4], water may evaporate quickly or absorbed by the surface and hence the paste is getting hardened within a short period. This creates poor workability and low mechanical strength of the applied coat. Usually, painters are applying two skim coat layers keeping a few hours gap between first and second coats, also total coat thickness depends on the condition of the surface to be finished. Usually, good quality skims coat suppliers are recommending their product to apply 1-2 mm thickness per coat and fill up to 8 mm total thickness. After the applied surface is fully dried or after 24-48 hours painters are sanding the surface using suitable sandpaper to prepare leveled, smooth surface before paint application. Again the quality of the skim coat plays a big role to get the required final finish of the surface to be painted. Because, if the dried skim coat surface is too hard, sanding is difficult and scratch marks may appear while more labor hours needed to finish the job. On the other hand, if the applied surface doesn't have enough surface hardness again chalking maybe happened and badly affected the final surface finish.

To be a good dried skim coat/layer, water-resistance and waterproofing properties should be high, water absorptivity should be less. Water-resistance is a measure of relative solubility of the dried skim coat layer. Water absorption is used to determine the amount of water absorbed under specified conditions. Waterproofing is the process by which a substance is applied to a surface, which renders the surface impermeable to water. Simply put, it creates a barrier that makes it impossible for water to pass through the material.

When considering the performances of the applied skim coat, major problems were poor adhesion strength, low compressive strength, low flexural strength, poor water resistance, and high water absorption [7]. If the relevant skim coat products don't have enough adhesion strength with the surface it will peel off from the surface with the valuable paint layers and affect the aesthetic finish of the surface badly. Also, having a low compressive and flexural strength of the skim coat tends to damage by even with a low impact force on the surface. Importantly due to high water absorption, the finished surfaces will be badly affected by efflorescence. Also, the metal structure of the concrete will corrode due to the same phenomena

[8]. Efflorescence is due to the precipitation of water-soluble salts on the skim coat surface. Here salts dissolved in the pore water and migrate to the surface and precipitate by evaporating water. In the cement-based skim coat, Calcium Carbonate is the most typical phase for primary efflorescence [5]. When porous construction structure contact with water, water-soluble salts can be transported by capillary forces to the surface resulting in secondary efflorescence [5]. Also due to poor water resistance, high water absorption and without waterproofing property, the product can not apply on the exterior surfaces or inside surfaces of the boundary walls and blind walls. Nowadays most of the blind walls can't access easily even for repairing work and the cost of other waterproofing coatings was comparatively higher side, therefore industrial demand for the cement-based skim coat having low water absorption properties justified. Figure 1.2 shows a damaged paint surface due to efflorescence.



Figure 1.2: Damage surface due to Efflorescence

1.3 Research Objectives

- ✓ To study the impact of RDP on selected properties of cement-based skim coat and compare with the control sample.
- ✓ To study the effect of cellulose thickener on selected properties of cement-based skim coat.
- ✓ To compare the test results with market products and control sample

1.4 The rationale of the study

Even though there are much research has been done under the topic of cement mortar there were very limited studies under the cement base skim coat and no one had explained results under industrial conditions [5]. Therefore this study will be able to full fill that gap.

1.5 Significance of the Research

In this study, it has been described the cement base skim coat manufacturing process with different formulations and properties. Newcomers to this industry can have a sound knowledge of Cement-based skim coat manufacturing by referring to this study. Since it has been described the properties by changing the formulation components and relevant amounts, this study can be used as a referring material for future research in the cement base skim coat industry. Also, users of the skim coat from the building construction industry can refer this study for their materials selections based on the application.

CHAPTER 2: LITERATURE REVIEW

In this section discuss the current skim coat market in Sri Lanka, available similar skimming compounds, the general composition of the product, quantitative and qualitative testing of skim coat dry powder, fresh skim coat paste and final properties of the applied product.

2.1 Details of available skim coat brands in the Sri Lankan market

Market research was conducted to get a clear idea about the skim coat market in Sri Lanka. According to the available data over 50 skim coat manufacturers are distributing their products throughout Sri Lanka in different capacities while one of large scale manufacture exports their skim coat products to cater to the foreign market as well. The general demand of the cement base skim coat in Sri Lanka per month is approximately 500,000 bags (20 kg/bag). Most of the manufacturers are using polythene packaging while few manufactures are using paper packaging to pack their skim coat powder. Therefore the skim coat market in Sri Lanka is very complex and needs to regularize the quality of the skim coat. The details of the market research are summarized in table 2.1. The retail price has varied in a range from 500 to 700 LKR.

Table 2.1: Details of the market research of Skim Coat

Brand Name	Details of Manufacture	Retail Price/bag(LKR)	MRP (LKR)
SF-Skim Coat	St.Anthony's Coatings (Pvt) Ltd	650	985
Aero Flex	Color Right Industries	550	750
Nippo Coat	Nippon Lanka, Rajagiriya	650	985
Asian Paint	Asian Paint Lanka (Pvt)Ltd	620	1550
DPC	Dhanushika paint & Chemicals	550	750
Keshara	Kesahara Minerals & Chemicals	650	850
Madhushika	Madhusika Paint, Bokundara	550	850
Mitsuki	Ruhunu Lanka Cement	550	945
Swisstek	Swistek Ceylon PLC,Nawala	620	920
Eagle	Embilipitiya Stores, Embilipitiya	550	800
Multilac	Macksons Paint Lanka, Panadura	550	900
Kansai	Kansai Paint Lanka, Colombo 02	650	850
Thames	Thames Coatings, Battaramulla	575	750
Zola	IPC Worldwide Resources,	500	950
Hega	Snow flow Industries, Mattegoda	550	850

2.2 Available compounds similar to cement-based skim coat

The acrylic base joint compound in paste form, Gypsum base skim coat in dry powder form, hydrated lime in paste form and latex powder based surface smoothing products are having similar applications with cement-based skim coat product. Acrylic-based ready to use joint compound or wall putty can be directly applied on the selected surface. Dry powder form products should be mixed with water before apply according to the mix proportion suggested by the manufactures. Table 2.2, 2.3 and 2.4 show typical formulations of the relevant products.

Table 2.2: Basic formulation of gypsum base skim coat

Basic formulation ingredients	% by weight
Calcium sulfate hemihydrate	70-80
Hydrated lime	1-5
Dolomite powder < 150 µm	20-30
Calcium Sulfate retarder	0.1-0.3
Cellulose fiber <150 µm	0.3-0.6
Cellulose thickener (High viscosity)	0.3-0.6
Re-dispersible polymer powder	1-2
Water	Approx.45-50

Table 2.3: Typical formulation of Latex powder base smoothing compound

Basic formulation ingredients	% by weight
Dolomite powder < 150 microns	65-75
Mica filler	10-20
Clay filler	5-20
Hydrated Lime	1-5
Cellulose Thickener (medium to high viscosity)	0.4-0.6
Re-dispersible polymer powder	4-6
Water	Approx.40-45

Table 2.4: Typical formulation of Acrylic base wall putty/Joint compound

Basic formulation ingredients	% by weight
Water	25-30
PH regulator	0.0-0.1
HEC (low to medium viscosity)	0.4-0.6
Defoamer	0.1-0.2
Dispersing agent	0.1-0.3
Wetting agent	0.2-0.3
Preservative	0.2-0.3
Dolomite Powder < 100 µm	60-70
Kaolin	3-5
Thickener(Acrylic/Mineral)	1-2
Acrylic binder	4-7

2.2.1 Lime as a construction material

Lime has more than 2000 years of history as a construction material. Lime can be used for external and internal applications. The main applications of the lime were making walls, floors, the conduit for water, joint filling and as a decorative compound. Further, it was a main binding material before introduced cement mortar/concrete and used for the construction of the world's most famous buildings.

There are three main steps in lime mortar production which called a lime cycle [9].

Step I: $\text{CaCO}_3 + \text{heat} \rightarrow \text{CaO} + \text{CO}_2$ Calcination

Step II: $\text{CaO} + \text{H}_2\text{O} \rightarrow \text{Ca}(\text{OH})_2 + \text{Heat}$ Hydration

Step III: $\text{Ca}(\text{OH})_2 + \text{CO}_2 \rightarrow \text{CaCO}_3 + \text{H}_2\text{O}$ Carbonation

2.2.2 Gypsum as a construction material

Gypsum is one of the old construction material which can mainly use in interior applications. It can be used as a surface finishing material to obtain smooth decorative finish to the wall and ceiling. It has low water resistance ability, hence restricted to the only interior applications. Gypsum also used in plaster to replace the cement sand plaster and skim coat layer. In present days gypsum manufactured as a prefabricated unit (Example-Gypsum board) which is bought at the time of installation [10].

2.2.3 Joint Compound/Acrylic based Wall Putty

Ready-mix paste form joint compound is a smoothing compound that is designed for fast application and easy maintenance. This product is a mixture of water, limestone, kaolin, acrylic binder, hydroxyl ethyl cellulose thickener, preservative, dispersing agent and the other ingredients. The required mixture of compounds gives a creamy texture appearance that spreads easily onto drywall surfaces, typical surfaces are cement plaster, concrete, gypsum partition board, and asbestos ceiling sheets. After that, the mixture hardens as the moisture evaporates. The ready-mixed joint compound has been more forgiving than the typical setting type of joint compound. It can be used for a long period as required, and that does not dry up unless otherwise, it left unattended for a long period, but that must be kept from freezing. The temperature above 13 °C is the typical working temperature for this type of compound, and the other requirement is all of the mixture materials should be at the same temperature.

There are three types of premixed joint compounds.

- The premixed taping compound which is using for bedding and taping coat.
- Finishing or topping compound which is using for filling and finishing coats.
- The general-purpose joint compound which can be used in bedding and taping coat, filling and finishing coats [2].

Usually, the acrylic-based joint compound is not water-resistant and recommended for interior applications only. Figure 2.1 shows the application of a joint compound using a putty knife.



Figure 2.1: Joint compound application using a putty knife

2.3 Composition of a White Cement based skim coat

Table 2.5 shows the typical formulation of cement base skim coat wall putty,

Table 2.5: A typical formulation of cement base skim coat

Basic formulation ingredients	% by weight
Portland Cement CEM 42.5 N (white or Grey)	15-20
Calcium Magnesium Carbonate < 150 microns	80-85
Pigments	0-5
Cellulose Thickener	0.3-0.5
Re-dispersible polymer powder	1-2
Water	Approx.35-40

2.3.1 White Cement

Other than the high degree of whiteness, both white cement/white ordinary Portland cement (WOPC) and ordinary gray Portland cement are similar. White cement is more expensive than the gray cement since white cement needs extra processing conditions and high raw materials cost with white cement. Substance like iron or manganese gives a grey color. WOPC is made from raw materials that have little or no iron or manganese. WOPC process is required 40% higher energy consumption than the grey Portland cement. Since WOPC is used to produce brightly colored concrete and mortars, White Portland cement is predominant with decorative/colorful works and prestige construction projects. That is why WOPC is used with interior and exterior decorations. White Portland cement is used in the highway road to increase visibility. White Portland cement is a powdery material and that becomes harden with water under mixing. It acts as a binder, also with some natural and artificially processed aggregates such as sand and gravel with the production of mortar, plaster, and concrete. It is the metal oxides primarily iron and manganese that influence the whiteness and undertone of cement. Table 2.6 shows the specification of white cement [11].

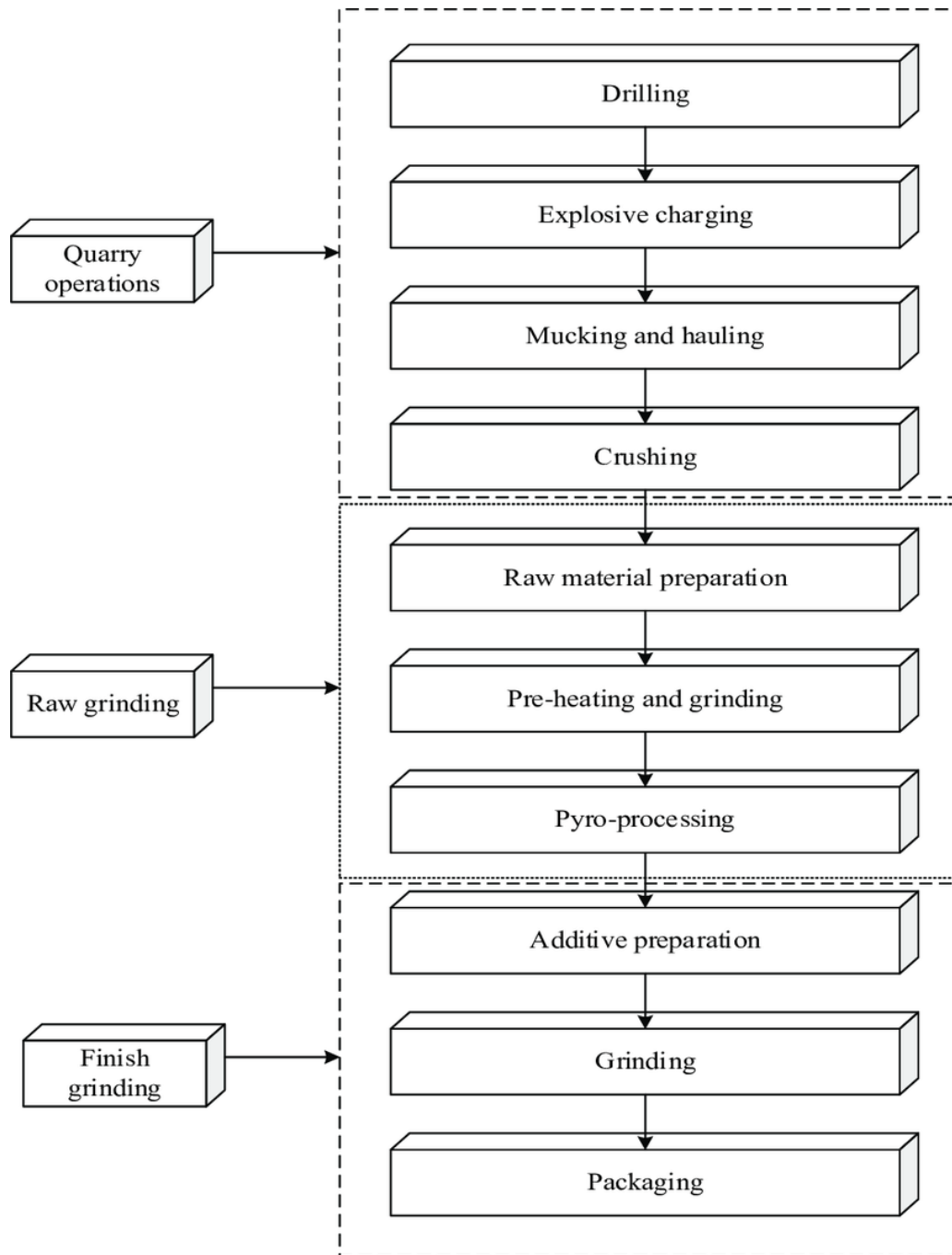

Figure 2.2: Cement manufacturing process

Table 2.6: Specification of White cement

Physical and Chemical properties			Test method	ASTM C 150 Specification
Air Content		%	ASTM C 185	12.0 max.
Blaine		m ² /kg	ASTM C 204	280 min.
Autoclave expansion		%	ASTM C151	0.8 max.
Compressive strength			ASTM C 109	
	-3 days	psi		1740 min.
	-7 days	psi		2760 min.
	-28 days	psi		4060 min.
Setting time, Gilmore test			ASTM C 266	
	-Initial setting	minutes		60 min.
	-Final setting	hrs		10 max.
Whiteness(Kett meter C100 type)		%	Kett meter C100 type	80
Silicon Dioxide	SiO ₂	%	XRF	21
Aluminum Dioxide	Al ₂ O ₃	%	XRF	4.5
Ferric Oxide	Fe ₂ O ₃	%	XRF	0.3
Magnesium Oxide	MgO	%	XRF	6 max.
Sulfur Trioxide	SO ₃		XRF	
	- 3 CaO. Al ₂ O ₃ <8	%		3 max.
	- 3 CaO. Al ₂ O ₃ >8	%		3.5
Chromium 6+	Cr6+	ppm	UV-VIS	0.1
Loss on Ignition	LOI	%	ASTM 114	3.0 max.
Tri Calcium Silicate	C3S	%	Calculation	60.54
Di-Calcium Silicate	C2S	%	Calculation	15.94
Tri Calcium Aluminate	C3A	%	Calculation	12.09
Combined	CaO	%	Calculation	64.58

In applications, white cement shows two main reactions to water.

- ❖ Porous and unstable $\text{Ca}(\text{OH})_2$ formation to facilitate aggressive water and chemical attack. This calcium hydroxide formation is around 25% of the cement by volume.
- ❖ White cement contains pozzolans react with the calcium hydroxide and make dense cement matrix with a fibrous cluster like network forming. Therefore the water flow through cement which is called tightness will be reduced. This prevents the deterioration of cement by preventing the entering of chemicals through the matrix.

The greenish-brown color of OPC (Ordinary Portland Cement) derives from many transition elements in its chemical composition. The coloring effect will be reduced according to the descending order of the following d block elements.

Cr Mn Fe Co V Ni Ti

White cement has low contents of those ingredients ($\text{Cr}_2\text{O}_3 \leq 0.003\%$, $\text{Mn}_2\text{O}_3 \leq 0.03\%$, $\text{Fe}_2\text{O}_3 \leq 0.35\%$), Generally, Mn and Fe occur together in nature. Therefore if Mn is low in cement, it is in a light color or more closer to white.

2.3.1.1 Hydration of Portland Cement

After water mix with cement, a series of chemical reactions start which calls the hardening of cement through the chemical process called hydration. Majority of the components which are in cement form chemical bonds with water molecules in cement hydration to become hydrates or hydration products. If the water contains impurities, that will weaken the cement paste due to side reactions. Also, this will interfere with the cement hydration process. [12]. Controlling the cement to water ratio is very important to get desired properties in cement paste since water act a major role in the cement hydration process. But if cement paste has too much water, it weakens the final product due to the high rate of cement hydration. In a normal Portland cement typically contained five major components as well as some minor components. The typical composition of the Portland cement as in Table 2.7 in weight percentage.

Table 2.7: Composition of OPC with chemical composition and weight percent

Cement Compound	Weight Percentage	Chemical Formula
Tricalcium silicate	50%	Ca_3SiO_5 or $3\text{CaO}\cdot\text{SiO}_2$
Dicalcium silicate	25%	Ca_2SiO_4 or $2\text{CaO}\cdot\text{SiO}_2$
Tricalcium aluminate	10%	$\text{Ca}_3\text{Al}_2\text{O}_6$ or $3\text{CaO}\cdot\text{Al}_2\text{O}_3$
Tetracalcium aluminoferrite	10%	$\text{Ca}_4\text{Al}_2\text{Fe}_2\text{O}_{10}$ or $4\text{CaO}\cdot\text{Al}_2\text{O}_3\cdot\text{Fe}_2\text{O}_3$
Gypsum	5%	$\text{CaSO}_4\cdot 2\text{H}_2\text{O}$

The final product strength only depends on calcium silicate. Tri calcium silicate contributes to the early strength (first week) while dicalcium silicate reacts slowly to contribute to the late strength. When cement mix with water each component undergoes the hydration and contributes to the final product properties.

The typical equation for hydration of the tricalcium silicate can be given by:

Tri calcium silicate + Water \rightarrow Calcium silicate hydrate + Calcium hydroxide + heat

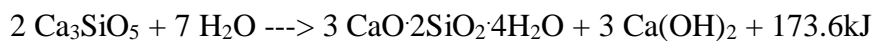

Tricalcium silicate can rapidly react to release calcium ions, hydroxide ions while generating a significant amount of heat. Due to hydroxide ion formation pH goes up to 12 rapidly. But the rate of initial hydrolysis slows down quickly after it starts resulting in a decrease in heat evolved.

But until the system become saturated, this hydration reaction happens at a slow rate. Under the saturation condition, calcium hydroxide begins the crystallization while calcium silicate hydrate formation. Ions precipitation in the solution accelerating the reaction of tricalcium silicate to calcium and hydroxide ions. Under this condition, heat evolution is very high.

Calcium silicate hydrate crystals act as seeds for the crystallization to form more crystals. But when the size of the crystal is increasing water has disturbances to reach un-hydrated tricalcium silicate to react. So the rate of the reaction goes down with crystal formation.

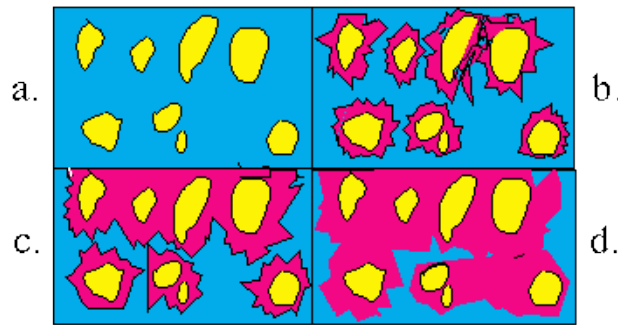
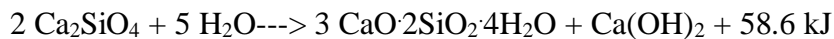

Figure 2.3: Pores in calcium silicate through different stages of hydration

The above diagrams represent the formation of pores as calcium silicate hydrate is formed. Note in the diagram (a) that hydration has not yet occurred and the pores (empty spaces between grains) are filled with water. Diagram (b) represents the beginning of hydration. In diagram (c), the hydration continues. Although empty spaces still exist, they are filled with water and calcium hydroxide. Diagram (d) shows nearly hardened cement paste. Note that the majority of space is filled with calcium silicate hydrate. That which is not filled with the hardened hydrate is primarily calcium hydroxide solution. The hydration will continue as long as the water is present and there are still un-hydrated compounds in the cement paste.

Dicalcium silicate also affects the strength of cement mortar/concrete through its hydration. Dicalcium silicate similarly reacts with water compared to tricalcium silicate, but much more slowly. The heat released is less than that by the hydration of tricalcium silicate because the dicalcium silicate is much less reactive. The products from the hydration of dicalcium silicate are the same as those for tricalcium silicate:

Dicalcium silicate + Water \rightarrow Calcium silicate hydrate + Calcium hydroxide + heat



The other major components of portland cement, tricalcium aluminate, and tetra calcium alumino ferrite also react with water. Their hydration chemistry is more complicated as they involve reactions with the gypsum as well. Because these reactions do not contribute significantly to strength. Although we have treated the hydration of each cement compound independently, this is not completely accurate. The rate of hydration of a compound may be affected by varying the concentration of another. In general, the rates of hydration during the

first few days ranked from fastest to slowest, as; Tricalcium aluminate > tricalcium silicate > tetra calcium alumino ferrite > dicalcium silicate.

2.3.2 Cellulose Thickeners in Skim coat

Methyl hydroxyl ethyl cellulose (MHEC) [13] and Hydroxyl propyl methylcellulose (HPMC) are the most commonly used cellulose thickeners for cement-based skim coat products [14]. Other than these two main cellulose thickeners, Carboxyl methylcellulose (CMC) and Starch powder also use some of the manufactures. In Sri Lanka, most of the large scale manufacturers are using MHEC while other manufacturers are using HPMC as their thickener. Usually, Cellulose thickeners are long-chain organic polymer molecules as shown in figure 2.4 and figure 2.5. These are non-ionic and water-soluble as a result of the polar H in OH groups which are preferring to make hydrogen bonds with polar 'O' in water molecules.

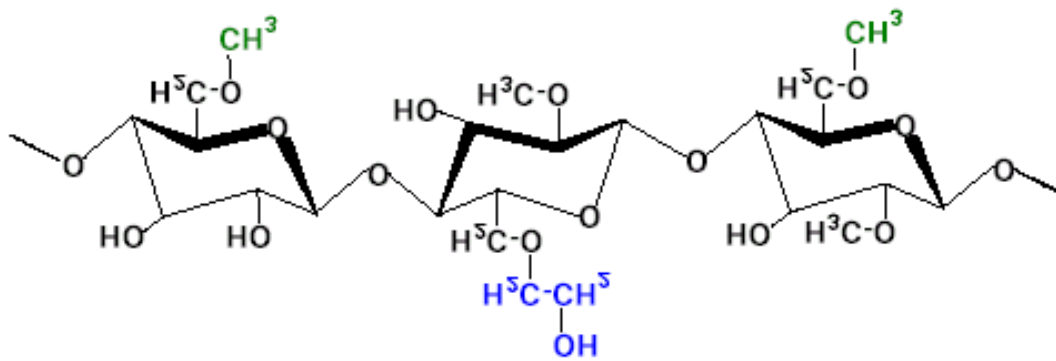

Figure 2.4: Structure of MHEC

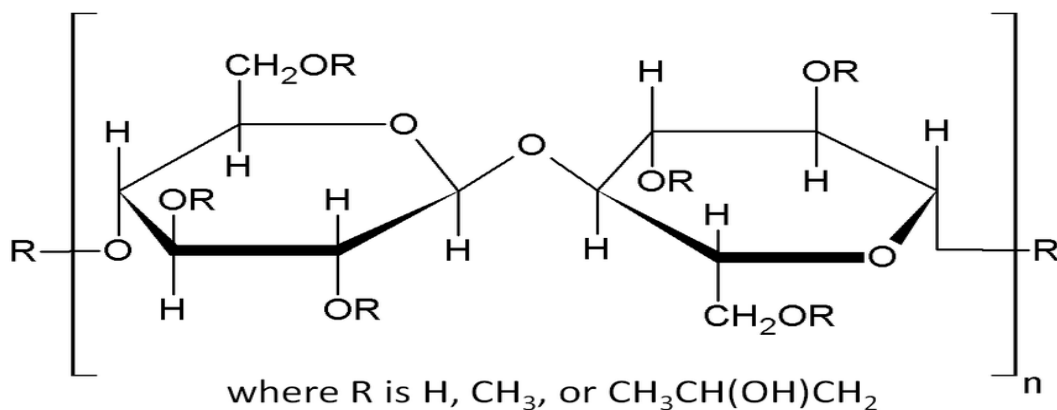

Figure 2.5: Structure of HPMC

By the etherification reaction of highly pure cotton-cellulose under the alkaline condition, Methyl Hydroxyl Ethyl Cellulose (MHEC) is manufactured. It is an odorless, tasteless and white powder. It is featured by hygroscopic and hardly soluble in hot water, acetone, ethanol, and toluene. MHEC will swell and create a colloidal solution in cold water and independent from the PH value of the medium. MHEC is soluble in water, has a high gel temperature and high resistance to the saline. Applications of MHEC; Cement-based skim coat, Water-based emulsion paint, Printing ink, Tile adhesive [15], Tile grout, Oil drilling, In construction and building material as a water-retaining agent and improving constructability, Decorative plaster, Dry and wet mortars, Detergent and Gypsum products, etc. [16].

2.3.3 Dolomite Powder

Dolomite or Calcium Magnesium Carbonate/ $\text{CaMg}(\text{CO}_3)_2$ powder is one of the main fillers in the decorative industry. In dry mix industry (such as skim coat, tile grout, tile adhesive), Joint compound, latex primer, and paints, fertilizer (as a source of MgO), metal processing, rubber products, ceramics, glass, are few of applications [17]. Dolomite is available as rocks and by mining obtained dolomite in lumps form. Mainly Dolomite rocks available in Sri Lanka at Digana, Matale, Balangoda, Embilipitiya, Buttala, and Maligawila. Usually Dolomite available with other minerals such as Calcite, Granite, Quartz .etc. Dolomite is in the Hexagonal crystal family. Available in pure white, but with the presence of impurities yellow, reddish and blackish as well. To obtain Dolomite in powder form lumps are grinding using roller mills. According to the required particle size used technology and machinery will be deference. Usually, Limestone is pure Calcite as Calcium Carbonate (CaCO_3) and a little expensive than Dolomite. Hence for the dry mix application commonly use Dolomite powder over Limestone powder. In Sri Lanka cement-based skim coat industry used Dolomite powder with particle size varies from $150\mu\text{m}$ to $200\mu\text{m}$ when considering the color of the powder it may vary white to off white.

2.3.4 Re-dispersible Polymer Powder (RDP)

An aqueous solution of vinyl acetate-ethylene copolymer dispersion spray drying to obtained white free-flowing RDP powder. In this spray drying, atomized the aqueous polymer dispersion in a steam air. When RDP powder blended with water, redisperse back resulting liquid or emulsion polymer with identical properties to the original dispersion [18].

Uses of RDP; Cement-based skim coat, Gypsum plaster, Cement Renders, Joint fillers, Repair mortars, Cement-based tile adhesive, Crack fillers, etc.

Advantages of using RDP in Cement-based dry mix products can be listed as follows;

It has excellent hydrophobic and water repellent properties, improves the workability, plasticity, abrasive resistance, adhesion, compressive, tensile and flexural strengths of the compound. Also, RDP can reduce the effect of shrinkage by reducing the formation of cracks, also improve the impact resistance and slip resistance [18].

Mechanism of action of RDP in a cement-based compound;

When RDP blended dry mix compound is mixed with water, it begins the modification of cement mortar by redispersing polymer powder, film formation, and cement hydration. There are three steps in the film-forming process in a mortar by RDP.

In step I,

When RDP blended dry mix compound is mix with water, polymer particles emulsified again and redispersed into the fresh cement mortar uniformly. During the mixing stage, although RDP particles dispersed within the cement paste themselves, they will not agglomerate with the cement particles. RDP gives very good application performance to the cement mortar due to its ‘lubricating effect’ and also improves the compressibility of the fresh mortar by giving easy application properties due to the ability of the polymer to increase the air-entraining effect into the fresh paste. During the mixing process, polymer powder dispersed into the fresh cement mortar, here an important role play by the protective colloids. Due to the strong hydrophilic nature of protective colloid, it gets the RDP to be completely dissolved at low shear forces, thus releasing the initial dispersed particles without changes in nature, and thereby polymer powder can be redispersed. Due to this quick redispersing ability in water is a key performance that enhances the effect of polymer.

In step II,

Free water inside the pores will be continuously reduced by cement hydration, absorption by substrate and evaporation from the surface. Then mobility of the polymer particles will be highly restricted. Due to water-to-air interfacial tension, they are arranged in the capillary pores of the cement mortar or mortar-substrate interfacial area. When mutually contact of the polymer powder, due to capillary action evaporate the network like moisture between particles. This will create high capillary tension and applied to the surfaces of polymer particles, then particles fused by deformation of the polymer sphere. At this stage, roughly film will be formed.

In step III,

By the diffusion of polymer molecules, form a water-insoluble continuous film in the mortar by polymer powder, it will modify the mortar and improve the bonding with the interface [19].

2.4 What is water-proofing and importance in the decorative industry

Water-proofing is a method which prevents water from penetrating a structure of building/house. Water-proofing is very important as it helps keep structure/surface dry. Also, it helps to reduce humidity inside the building/house and thereby protects things inside the building/house from damage caused due to humidity or water exposure.

To prevent the water penetration or intrusion to the structural elements or finished surfaces of a building, there is a combination of materials can be used, this process is called as waterproofing. The moisture in the liquid state creates the hydrostatic pressure and it can be overcome by waterproofing the surfaces.

Therefore, it is very important to water proof of the buildings or houses from possible damage due to water intrusion. If there is no waterproofing, it will lead to develop and propagate the cracks, peel off the expensive paint and mold, growing of mildew, fungus and air pollutants. Also, it will create a great risk for the foundation and internal structure of the buildings.

CHAPTER 3:

EXPERIMENTAL METHODOLOGY

3.1 Research Plan

To study the performances of dried skim coat layer of white cement based skim coat through water absorption controlling by RDP addition, 06 sample formulations were designed and 03 market products were selected. As per the control sample) 0 % RDP sample was selected. Two sample formulations were designed to investigate the effect of MHEC in skim coat formulations.

3.2 Materials

Application performances depend on the amount of cellulose thickener. Waterproofing and water absorption mainly depends on the addition of hydrophobic RDP powder. In a basic white cement skim coat formulation, white cement with strength class 42.5 N acts as a binder material. Calcium Magnesium carbonate powder (Dolomite powder) used as a filler (Usually below 150 microns in particle size). Generally, Methyl hydroxyl ethyl cellulose (MHEC) or Hydroxyl Propyl methylcellulose (HPMC) or carboxyl methylcellulose (CMC) can be used as a thickener. For this study, MHEC was selected as the thickener. A modified or un-modified vinyl acetate-ethylene copolymer (RDP powder) used as performance improvement additives. Materials selection was designed under three trial sets as in 3.2.1, 3.2.2 and 3.2.3.

3.2.1 Trial set 01

Materials were selected to investigate the effect of MHEC on the cement-based skim coat.

- White cement
- Cellulose thickener
- Dolomite powder
- Water

3.2.2 Trial set 02

Materials were selected to investigate the effect of RDP percentage in improving the properties of a cement-based skim coat.

- White cement
- Cellulose thickener
- Dolomite powder
- Water

3.2.3 Trial Set 03

Three available three market products were selected from table 2.1. All three products are white cement-based skim coat in dry powder form.

3.3 Method

The method can be described under three categories as in 3.3.1, 3.3.2 and 3.3.3

3.3.1 Investigation of MHEC on a cement-based skim coat.

In this materials selection, MHEC percentage was the variable and other ingredients kept constant except dolomite powder as in Table 3.1

Table 3.1: Formulations of tested samples

Sample no.	White cement	Cellulose Thickener	Dolomite powder
SAM 01	150	0	850
SAM 02	150	2	848
SAM 03	150	4	846

3.3.2 Design formulations to investigate the effect of RDP percentage

In this materials selection, RDP percentage was the variable and other ingredients kept constant except dolomite powder as in Table 3.2.SAM 03 was used as the reference sample.

Table 3.2: Formulations of tested samples

Sample no.	White cement	Cellulose Thickener	Dolomite powder	RDP Powder
SAM 03	150	4	846	0
SAM 04	150	4	841	5
SAM 05	150	4	836	10
SAM 06	150	4	831	15
SAM 07	150	4	826	20
SAM 08	150	4	821	25

3.3.3 Method to compare the properties with optimum sample

20 kg from each market products were taken and labeled as CON 1, CON 2 and CON 03.

3.3.4 Skim coat preparation methods

Skim coat preparation can be divided into dry powder preparation and wet sample preparation as described in 3.3.4.1 and 3.3.4.2.

3.3.4.1 Dry skim coat powder preparation

Below steps were followed in the preparation of dry skim coat powder (20 kg of skim coat prepared from each formulation).

- ❖ According to the design formulations, relevant ingredients were weight,
- ❖ Then all powder ingredients were loaded into the lab-scale mixing chamber (ribbon mixer) and mix for 10 minutes to get a homogeneous powder mixture.
- ❖ Finally, the mixture was unloaded and packed.

3.3.4.2 Wet sample preparation

Below steps were followed in a wet sample/skim coat paste preparation, (Water to skim coat mixing ratio was kept constant at 35:100 by weight for all samples)

- ❖ As per the requirement, clean water takes into a clean container.
- ❖ Then, a measured amount of skim coat powder (as per the water: skim coat ratio) was added while mixing using an electric putty mixing machine until lumps free paste obtained for 6 minutes.

3.3.5 Three samples set testing methods

Here defined two sets of formulations and market samples were tested as per the test methods described below. SAM 03 was used as the reference sample. Each sample is used to test the workability of skim coating and final performances such as adhesion, compressive and flexural strength. Adhesion, flexural and compressive strength test, flow table test and setting times were performed by the help of a chemical supplier in their testing laboratory while capillary water absorption, pencil hardness test, surface water absorption, bulk density of dry powder and fresh skim coat paste were performed in house laboratory according to the designed formulations.

3.3.5.1 Determination of Bulk Density of dry skim coat powder

Dry skim coat sample powder pours using a teaspoon through a funnel to the glass cup until powder fill above the top level of the glass. After that carefully remove the excess powder using a ruler. All remained powder wipe using paper tissue and final weight of the glass with powder measured.

$$\text{Bulk density} = (W2 - W1)/V \quad \text{Equation 3-1}$$

Where;

W1= Empty weight of glass cup

W2= Final weight of the glass cup

V=Volume of the glass cup

The test was conducted as per the above and bulk density was calculated in kg/m³.

3.3.5.2 Determination of Bulk Density of fresh skim coat paste

The bulk density of fresh skim coat paste was determined by calculating the mass of the skim coat paste contained in a known volume.

First, fresh skim coat pastes prepared as described in 3.3.4.2, Then calibrated container (500 ml) was filled to approximately half of its height with the prepared fresh paste using a scoop, the container was then tilted about 30 mm on alternate sides and allowed to fall ten times on to a solid base. After that, the container was filled to overflowing and the shock compaction repeated. The edges of the container were wiped clean with a damp cloth and the container weighed.

The bulk density (kg/m³) was calculated by use of the below formula:

$$\text{Bulk Density} = (M2 - M1)/V \quad \text{Equation 3-2}$$

Where,

M1 = mass of empty container

M2 = mass of container plus skim coat paste

V = volume of container.

3.3.5.3 Determination of Open time of fresh skim coat paste

Drying of skim coat paste decreases the fluidity property of the paste. The fluidity property needs to be with paste in a desirable period to apply on the substrate and get a smooth surface. Hence, the open time is an important property and the in-house method was used to measure the time required to disappear the desirable fluidity of the fresh paste. It is a measure of the time required to disappear the specific fluidity of a thin layer of skim coat paste.

A fresh skim coat paste prepared according to the 3.3.4.2 procedure was applied on the clean asbestos ceiling sheet (100 mm*500 mm) and swept off, following this 2 mm thick even layer was applied again by using a scrapper. After 5 minutes the first cube was placed on the skim coat layer and maintained in position for 30 seconds. Then the cube was removed and the surface area of the contacted surface was observed. If the skim coat layer was not dried, part of the skim coating will transfer from the test panel to the cube face and cover the surface area of the cube face. The percentage of the surface area of the cube face covered by the skim coat paste was estimated. This procedure was repeated using fresh cubes at intervals of five minutes until 50% of the cube surface area was covered with adhering skim coat paste. Figure 12 shows the typical open time test.



Figure 3.1: Determination of the open time of fresh skim coat paste

3.3.5.4 Determination of setting time of fresh skim coat paste

A sample of fresh skim coat paste (400 g) was poured into the standard mold up to the top mouth of the mold. The mold was having a top and bottom diameter of 80 mm and 90 mm respectively and a height of 40 mm. The sample was flatted and the large needle (10 mm diameter) was connected as shown in figure 3-2. The needle was slowly lower until it contacts the top surface of the paste and quickly released allowing it to penetrate the paste [20]. The test

was carried out by changing the water content to determine the desired water content. At the desirable water content, the needle will reach to 5 mm to 7 mm from the bottom of the mold.

Generally, the initial setting time of cement was measured using the pin type needle with a 1 mm diameter. However, the needle touches the bottom of the mold even after the 1 hour of setting time of skim coat paste. Therefore, the large needle with a 10 mm diameter was used in the determination of the initial setting time. Initial setting time measure the time required to reach the 5 mm from the bottom of the mold when the paste prepared with desirable water content as determined above.

Final setting time measure using a needle with the annular attachment of the Vicat's apparatus. Final setting time was the time elapsed between powder mix with water and needle make an impression [20]. Figures 3.2 and 3.3 show the appearance of the Vicat apparatus and dimensions respectively.



Figure 3.2: Vicat needle apparatus

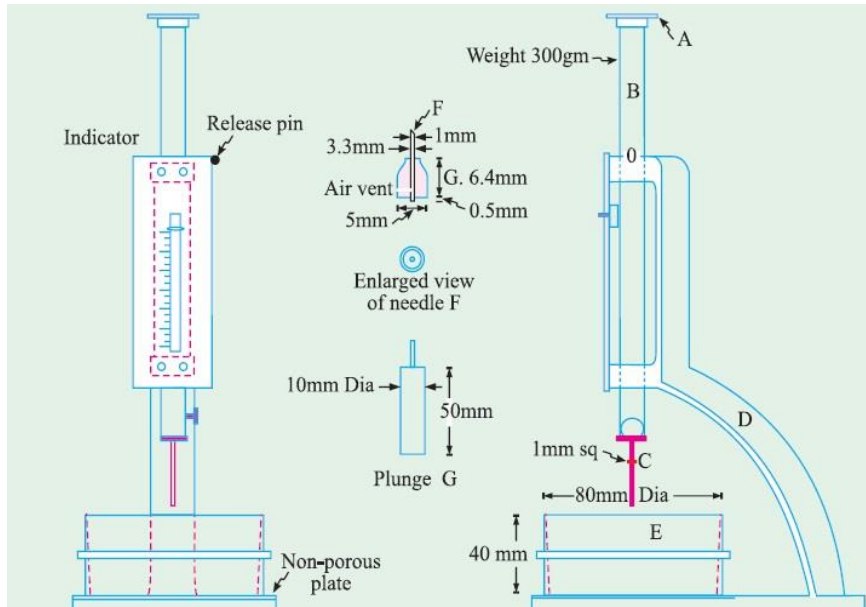

Figure 3.3: Dimensions of Vicat needle apparatus

3.3.5.5 Determination of flow properties of fresh skim coat paste

First, place the flow mold at the center of the flow table after properly clean and dry. Prepared a fresh skim coat paste (500 g) as per the given water: dry skim coat powder ratio in 3.3.4.2. After that place, a layer of fresh skim coat paste about 25 mm in thickness in the mold and tamp with tamper about 25 times. The mold was filled uniformly by giving enough tamping pressure to the surface of the skim coat paste. Again, filled the mold with fresh skim coat paste and tamp using the tamper as the first layer. Remove the excess paste by cutting off the skim coat paste to a plane surface flush with the top of the mold by drawing the straightedge metal ruler with a sawing motion across the top of the mold. Carefully remove the water from edges of the flow mold and clean, dry the flow table by wiping with a cloth. Lift the mold away from the fresh skim coat paste. Immediately drop the table 25 times in 15 seconds. When bumping, the paste was moved along the table radially outwards. In the end, total flow distance was measured using a ruler. If the mixture is viscous, the distance is low and vice versa. Figures 3.4 and 3.5 show the appearance and dimensions of the flow table.



Figure 3.4: Flow table

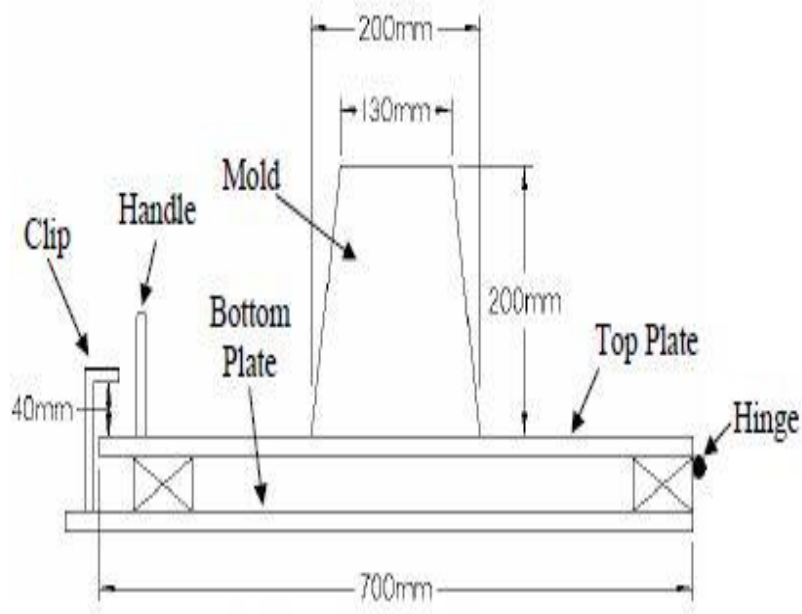

Figure 3.5 Dimensions of a flow table

3.3.5.6 Determination of flexural and compressive strength

Initially, the flexural test was carried out by using cured prism specimens with a three-point loading method and after the performing flexural strength, resulted in two pieces of prism used to measure compressive strength [21].

The prisms/test specimens are prepared using 40 cm*40 Cm*160 cm (Three prism specimens prepared using each mold assembly) mold compartments which are mineral oil lubricated before fill with fresh skim coat paste. The method of prisms preparation may vary with the type of binder used,

Prism specimen's preparation steps;

- Two layers of cotton gauze (white color) were laid on the glass plate and the mold was placed on the gauze layers.
- The mold was filled with two layers of fresh skim coat paste and each layer has been compacted with tamper by giving twenty-five strokes.
- Again the top of the compacted surface, two layers of cotton gauze and six layers of absorbent paper were placed following that a glass plate was placed.
- After that full assembly was turned up-side-down and the glass plate has been removed carefully, following that six layers of filter paper placed top of the cotton gauze and glass plate was placed.
- Following that, assembly re-turned upside-down and placed the weight of 5 kg on the glass plate and kept undisturbed for three hours.
- Removed top glass plate, filter paper, and gauze layers, again placed the glass plate. Turned upside-down, remove glass plate, filter papers and gauze layers.
- Finally, test specimens are cured in a polythene bag or curing chamber (within this initial curing period, prism specimens removed from the mold for part of the initial curing time)
- Final curing was done using a curing chamber.

The flexural strength is evaluated after the 28 days curing period of the prism specimens. As per the shown in fig 18 testing machine with two supportive rollers and loading roller (third roller) located top of the cured prism specimen and located middle of the two supportive rollers. After the placing of the test specimen, the load is applied until its brakes within 30 to 90 seconds of a period. With the aid of expression 3.1 flexural strength (f) was calculated.

$$f = \frac{1.5Fl}{bd^2} \quad \text{Equation 3-3}$$

Where;

b,d – dimensions (internal) of the test specimen mold,

l – Distance between two supportive rollers,

The flexural strength f is calculated to the nearest 0.05 N/mm² and the average value calculated to the nearest 0.1 N/mm² using three test results per sample.

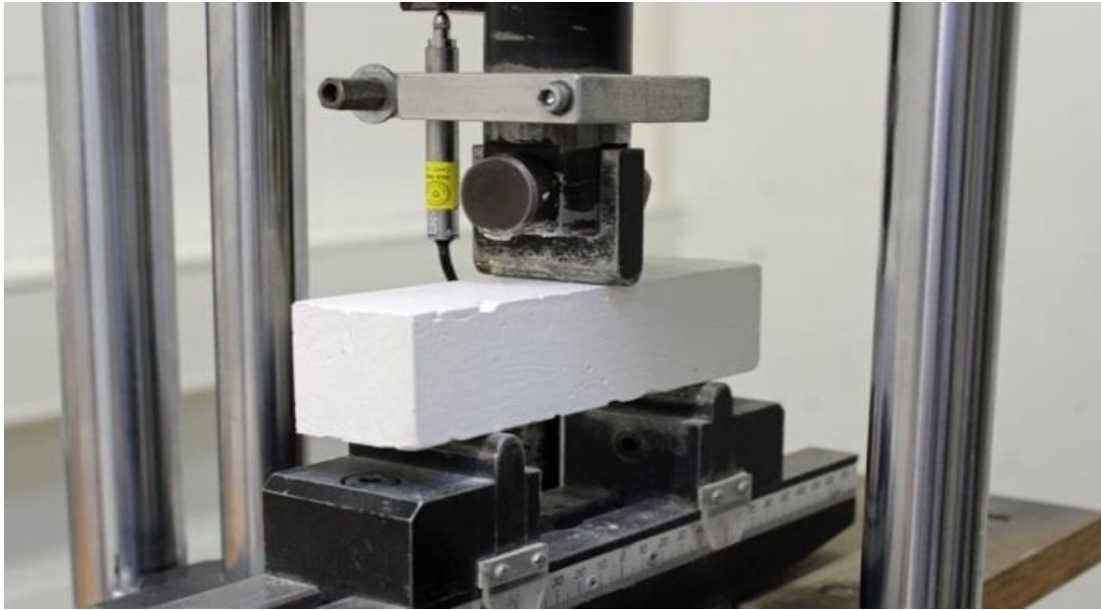

Figure 3.6: Universal Testing machine with skim coat cube of flexural strength test

The broken halves of the test specimen were used for the determination of the compressive strength by using a universal testing machine. This testing load is applied to a test specimen face cast against the metal face of the mold. After that similarly, the flexural strength test load is applied to the prism specimen till failure within 30 to 90 seconds period. The compressive strength was measured to the nearest 0.05 N/mm^2 and the average value reported to the nearest 0.1 N/mm^2 using three test results per sample.

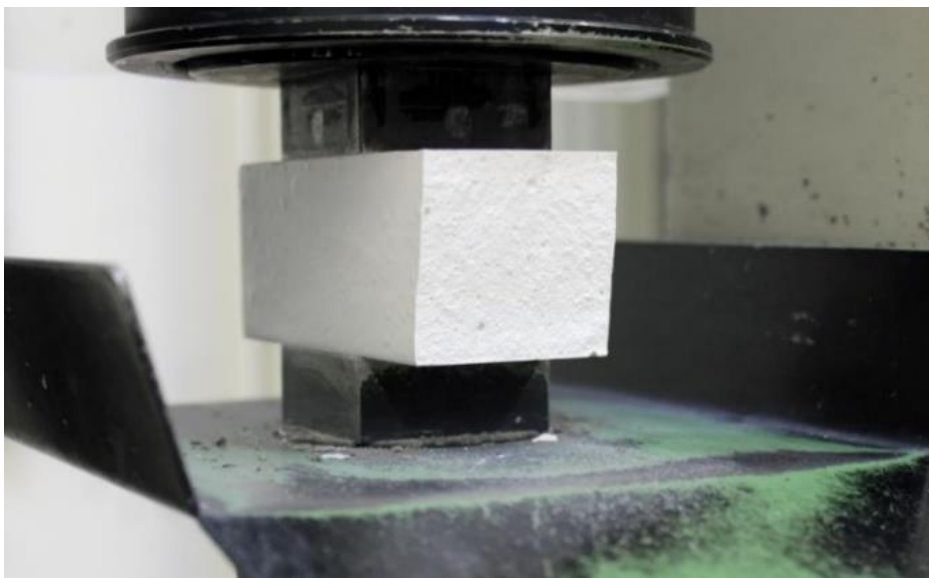

Figure 3.7: Test machine with skim coat cube for Compressive strength test

3.3.5.7 Determination of Adhesive Strength

The maximum tensile stress was calculated which applied by a direct load with right angles to the 2 mm thick dried skim coat layer surface. This test was carried out for the skim coat layer applied on the suitable concrete surface. The dimension of concrete test slabs is 550mm x 150mm and a thickness of 50mm was used. These test slabs prepared using a concrete mixture that has a 0.55 ratio of water-cement with sieved particles having one-third size of the slab thickness. The surface of the concrete slab leveled using a wood panel to obtain proper surface to apply to skim coat and cured for at least 28 days of a period before used for the test.

A 2mm thick fresh skim coat paste prepared as per the described in 3.3.4.2 was applied top of the concrete slabs. After the initial setting time of the skim coat layer, a sample was collected by pressing with an oiled sharp edge of a conical metal ring into the skim coat layer until it reaches a concrete surface. The dimension of metal ring height-25mm, internal diameter-50mm. The collected specimens are stored for one week inside the polythene bag which has a temperature of $20\text{ }^{\circ}\text{C} + 2\text{ }^{\circ}\text{C}$ airtight condition. After one week another three weeks kept inside the humidity chamber (temperature, $20\text{ }^{\circ}\text{C} + 2\text{ }^{\circ}\text{C}$, humidity, $65\% + 5\%$). The adhesive strength was conducted just after the test specimen removed from the humidity chamber.

By using epoxy resin or methyl methacrylate resin-based adhesive the full-off head is glued to the skim coat surface carefully. A perpendicular tensile load was applied by using a machine that connected to the pull-off head and at the failure of the sample applied tensile load is measured. According to the expected adhesive strength of the skim coat layer rate of the applied tensile load is varied. For one skim coat product, five test specimens are used and relevant adhesive strength was recorded to the nearest 0.05 N/mm^2 and the average adhesive strength calculated to the nearest 0.1 N/mm^2 .



Figure 3.8: The scheme of the pull-off method (a) a view of the testing device (b).

3.3.5.8 Determination of Capillary Water Absorption

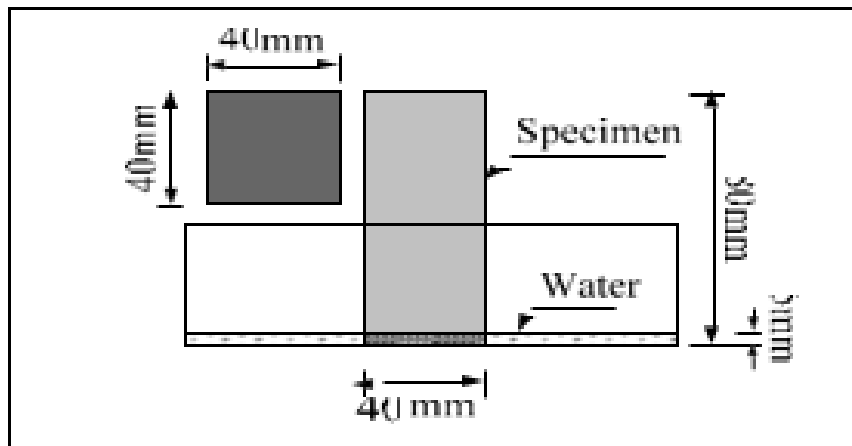

Figure 3.9: Capillary water absorption test- diagram

The test specimens which are properly cured and dried to the constant mass were selected for the test. Before commencing the test, top surface and long surfaces were sealed with paraffin wax to stop the evaporation and absorption of water. The un-waxed surface of the test specimen/prism was immersed to a depth of 5 mm in water for a specified period as per the above diagram and the increase in mass was determined after the surface water was wiped off with a damp cloth. The test specimens were replaced in the tank and the mass determined using the same procedure after every 10,30,90,120,240,360,480,600,720,900,1200 and 1440 minutes.

3.3.5.9 Determination of surface Water Absorption

A skim coat layer was applied to the ceiling to maintain a 2 mm thickness. It was allowed to dry until it reaches the constant mass and completes the curing period (14 days). The test specimens half of the surface area (75 mm*75 mm) and other all faces are sealed with paraffin wax to stop the evaporation and absorption. The initial weights of the test specimens were recorded using a weighing scale and the naked surface area (75 mm*75 mm) of test specimens were immersed to a depth of 75 mm in water for a specified period (150 min.). End of the water immersion the surface water is wiped off with a damp cloth and the mass determined.

M1-Initial weight of test specimen, M2-Final weight of test specimen,

A- Surface area of the immersed skim coated specimens

$$\text{Surface Water absorption} = (M2-M1)/ A \quad \text{Equation 3-4}$$

The units, of surface water absorption, is kg/m^2

3.3.5.10 Determination of surface hardness



Figure 3.10: Pencil hardness tester with a skim coated panel

A 2 mm thick skim coat layer was applied on an asbestos ceiling sheet (125 mm*175 mm) and the coating was allowed to cure for 7 days. The first pencil of the pencil hardness set to bear the softest tip of 9B. It was used to measure very low hardness values. 9H will be the hardest pencil and used to evaluate surfaces with the highest hardness. The pencil was gripped in the holder and moved over the already applied and dried skim coat surface. Dust was removed with the aid of a brush and the surface was observed to see whether there were scraped marks by pencil. The test was continued using pencils in the order of increasing hardness until a pencil scratch mark was observed. Then the hardness was taken as the previous pencil number which did not give any scratching on the coating. For example, if the scratch mark is given by 4B pencil, then the hardness of the applied layer consider as 5B. The test was performed for 2 designed sample sets and 03 market products. To compare the hardness of the samples, a hardness value was introduced according to the hardness of the pencil as shown in table 3.3. The hardness of the softest pencil (9B) was given hardness value 1 and the hardest pencil (9H) was given hardness value 20. The difference between the two nearest pencils was hardness unit 1.

Table 3.3: Order of Hardness of pencil kit

9B	8B	7B	6B	5B	4B	3B	2B	B	HB	F	H	2H	3H	4H	5H	6H	7H	8H	9H
1	2	3	4	5	6	7	8	9	10	11	12	13	14	15	16	17	18	19	20

CHAPTER 4:
RESULTS AND DISCUSSION

4.1 Test results-Bulk density of dry skim coat powder

Bulk density of all the formulations and market products given in Table 4.1 and Figure 4.1

Table 4.1: Bulk density of dry skim coat powder test results

Sample No.	Avg. Bulk Density (kg/m ³)	The volume of 20 kg bag (Liter)
SAM 01	972.8	20.56
SAM 02	965.6	20.71
SAM 03	960.2	20.83
SAM 04	958	20.88
SAM 05	955	20.94
SAM 06	951.8	21.01
SAM 07	947.6	21.11
SAM 08	944.5	21.18
CON 01	971.8	20.58
CON 02	977.9	20.45
CON 03	1012	19.76

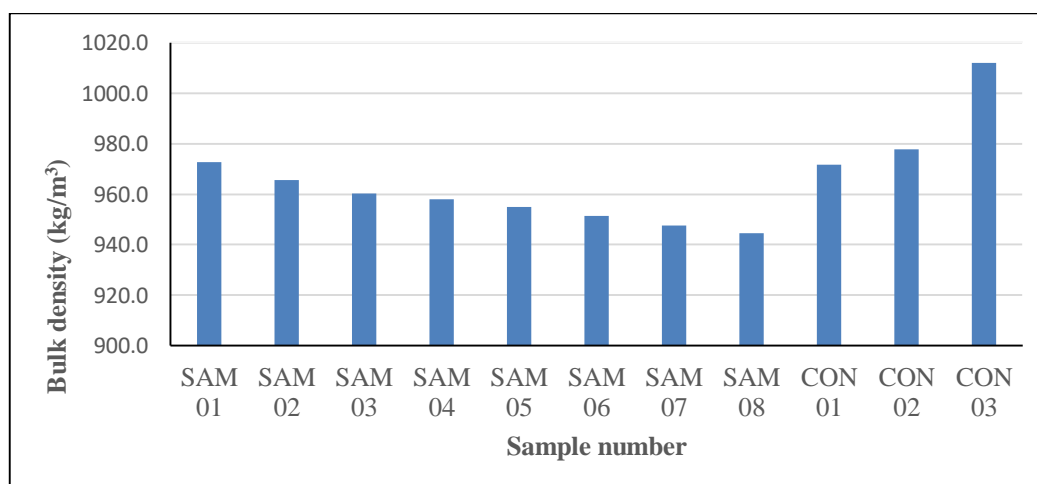

Figure 4.1: Bulk density of skim coat samples

In all formulations contained dolomite powder (Bulk density 1006 kg/m³) and White cement (Bulk density 935 kg/m³). Bulk density of MHEC and RDP powder was 355 kg/m³ and 503 kg/m³ respectively. When adding low-density bulky particles into the dry mix to partially replace relatively dense dolomite particles those will occupy more volume and reduced the compactness of main dolomite and white cement particles. This reduced the weight of unit volume.

4.1.1 Sample set 01

Since high-density dolomite powder was replaced with low bulk density MHEC, bulk density of the skim coat sample reduce from SAM 01 to SAM 03.

4.1.2 Sample set 02

Since high-density dolomite powder was replaced with low bulk density RDP powder, bulk density of the skim coat samples was reduced from SAM 03 to SAM 08.

4.1.3 Sample set 03

When considering 03 market products with the 08 designed samples, the bulk density of market samples was higher than except SAM 01 which contains white cement and dolomite powder. Bulk density of CON 01 has the lowest among the three while CON 03 has the highest value. Usually, the bulk density of the main component will be decided on the final density of a dry mix. Therefore CON 03 may contain a comparatively high amount of Dolomite powder with higher bulk density and less white cement content, Cellulose thickener while CON 01 may contain comparatively less amount of Dolomite powder and high amount of white cement and cellulose thickener. Also, the bulk density of relevant dolomite powder may be less. Likewise, CON 02 contained dolomite powder in between CON 01 and CON 03 values. When it decreased the bulk density of the skim coat powder, it will increase the volume required to pack 20 kg of product. Then the cost of packing may increase. But, the present bag/pack contained enough space for extra volume. Therefore, no impact on the cost of the packing.

4.2 Test results-Bulk density of fresh skim coat paste

Table 4.2 and figure 4.2 show the bulk density of fresh skim coat paste of designed formulations and market products.

Table 4.2 Bulk density of fresh skim coat paste test results

Sample No.	Average Bulk Density (kg/m ³)
SAM 01	1853
SAM 02	1822
SAM 03	1763
SAM 04	1772
SAM 05	1780
SAM 06	1781
SAM 07	1750
SAM 08	1739
CON 01	1770
CON 02	1782
CON 03	1791

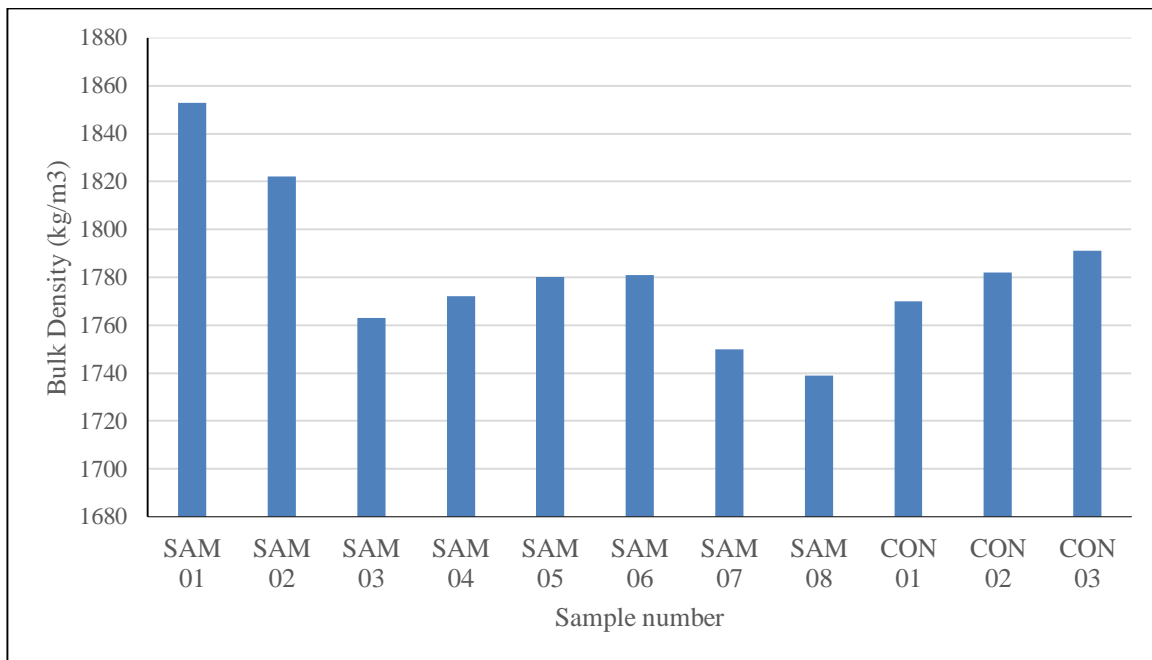

Figure 4.2: Bulk density of fresh skim coat paste

Several works published in the scientific literature describe the properties of fresh polymer-modified cement mortar [22] [23]. Bulk density can reflect the degree of compactness of materials. Since the mass ratio of water to dry skim coat powder is constant for all, the bulk density of paste is an indication of compactness. Adding MHEC/Cellulose thickener to the formulations, air-entrained into the fresh skim coat paste takes place and the amount of entrained air will increase with the percentage of the MHEC/Cellulose thickener [24]. Due to entrained air compactness will be decreased and bulk density will be reduced in the fresh skim coat paste [25].

4.2.1 Sample set 01

Since MHEC dosage was increased from SAM 01 to SAM 03, the bulk density of the fresh skim coat was decreased. In SAM 01 contained white cement and dolomite powder only. Therefore this bulk density difference directly related to the addition of MHEC.

4.2.2 Sample set 02

From SAM 03 to SAM 06 bulk density increased with increasing RDP powder content until it reached an optimal amount of approximately 1.5 wt. %, and then started to decrease. This indicates the impact of RDP powder on compactness and entrained ability of air into skim coat paste [2]. When the content of RDP powder increase from 0.5 wt. % to 1.5 wt. %, compactness increases. It was difficult to uniformly mix the skim coat powder with water due to entrained air. Air entrained ability becomes dominant when the RDP powder content exceeds 1.5wt. % and hence the bulk density of paste decrease when the content of RDP powder increase from 1.5 wt. % to 2.5 wt. %. Difficult to RDP powder content continued to increase because it was difficult to uniformly mix the skim coat powder with water. Due to this poor mixing performance, entrained air will be increased and bulk density decreased. The minimum density of 1739 kg/m³ corresponded to 2.5 % RDP content.

4.2.3 Sample set 03

The bulk density of the fresh paste of SAM 03 was lesser than the market products. Samples CON 01 shows the lowest bulk density and CON 03 show the highest value. Therefore compactness of the paste has increased CON 01<CON 02<CON 03 order. Even though CON 03 had high dry powder density its fresh paste density is not that high, which may be due to large particle size of the dolomite powder which decreased compactness of the particles.

4.3 Test results-Open time of fresh skim coat paste

Table 4.3 and figure 4.3 show the test results of the open time of fresh skim coat paste.

Table.4.3 Open times of fresh skim coat paste

Sample No.	Open time(minutes)
SAM 01	5
SAM 02	15
SAM 03	20
SAM 04	25
SAM 05	30
SAM 06	30
SAM 07	30
SAM 08	30
CON 01	15
CON 02	15
CON 03	10

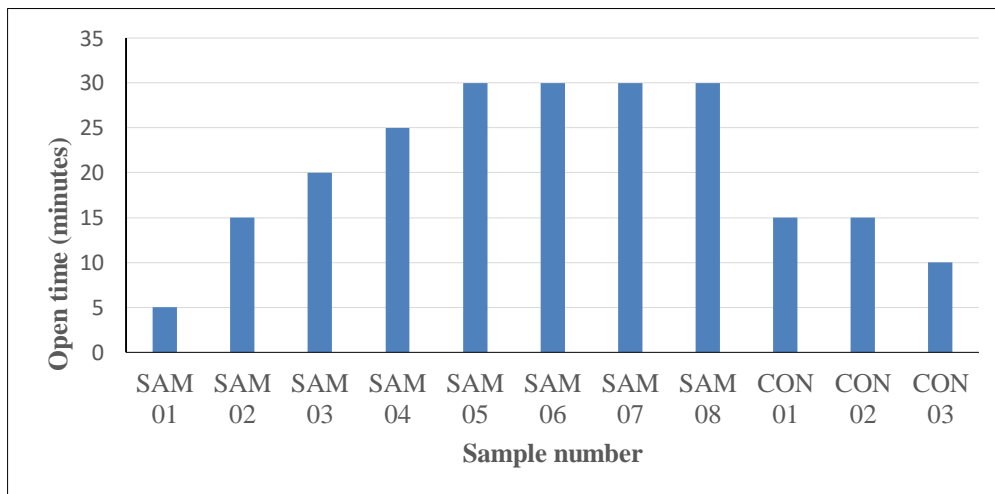

Figure 4.3: Open time of fresh skim coat pastes

Open time depends on the rate of water evaporation from the surface and absorption by the applied substrate (poor water retention). Under too fast drying and setting, workability/correction is very poor. Increasing the open time is desirable in practical situations to prolong the workability. By preparing more amounts of paste at a time to apply over the large surface areas of walls. But too much of open time is not desirable since the delay in drying increased the recoating time.

4.3.1 Sample set 01

MHEC can absorb water to retain water in the skim coat paste. When it was introduced open time has increased significantly even at 0.2 % wt. as in SAM 02. Increased the MHEC dosage, open time was increased further at 0.4 % wt. Therefore, we can identify a proportional positive relationship in open time with the dosage of MHEC. So, the open time has increased by increasing water retention.

4.3.2 Sample set 02

From SAM 03 to SAM 05, open time was increased. This should be due to the addition of RDP powder % by 0.5 wt. % to 1 wt. %. Again, not only MHEC but also RDP has an impact on increasing open time as well. When introduced RDP it will control the interdiffusion of water and increased the compactness, due to these effects reduced the water escaping from fresh paste increasing open time. But increasing further as in SAM 06, SAM 07 and SAM 08, there is no significant open time increment due to polymer particles agglomerate and reduced the compactness. At the dosage of RDP 1%-1.5% show optimum open time in the fresh skim coat paste.

4.3.3 Sample set 03

Open times of market samples were well lower than from SAM 05/SAM 06.

4.4 Test results-Setting times of fresh skim coat paste

The setting times of fresh skim coat paste of all formulations show in **Error! Not a valid bookmark self-reference.** and Figure 4.4

Table.4.4 Setting times fresh skim coat paste

Sample No.	Initial setting time(minutes)	Final setting time(minutes)
SAM 01	121	230
SAM 02	172	281
SAM 03	181	323
SAM 04	198	328
SAM 05	210	330
SAM 06	216	345
SAM 07	229	361
SAM 08	242	363
CON 01	177	290
CON 02	172	284
CON 03	169	278

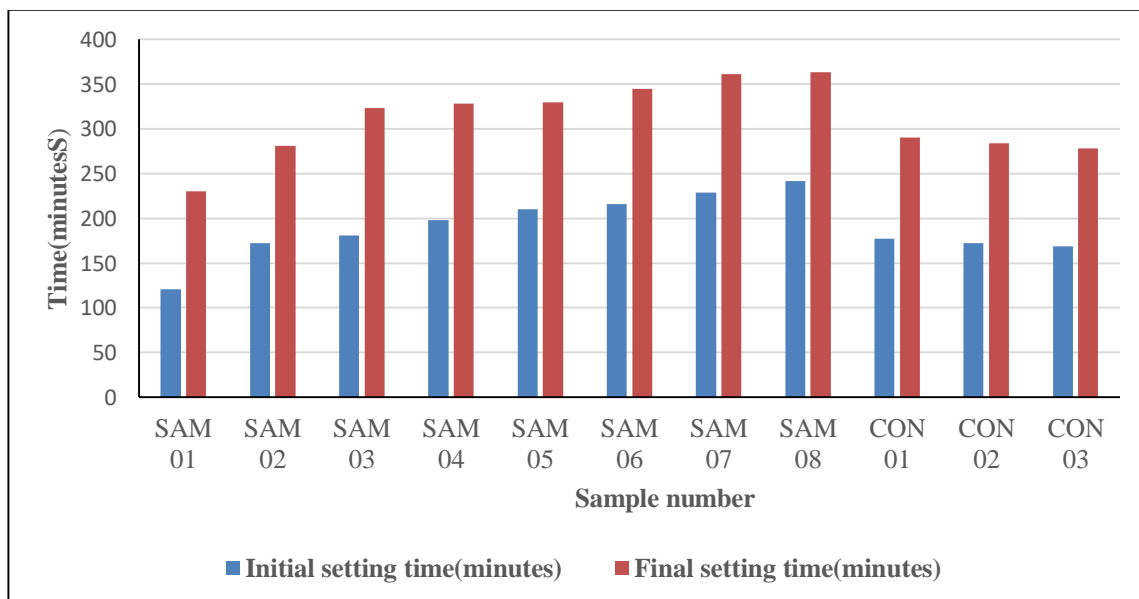

Figure 4.4: Setting times of fresh skim coat paste

When cement or cement contained a dry skim coat mixed with water to form a paste the chemical reaction starts, which is called hydration. In hydration mixture or paste starts to change from a fluid state to a solid-state. This is called an initial setting time of cement.

4.4.1 Sample set 01

Since SAM 01 had not any water retention components, cement hydration [26] rapidly takes place. Therefore setting time is low compared to SAM 02 and SAM 03. When MHEC added as in SAM 02 and SAM 03 water will be absorbed from the paste to reduce the rate of cement hydration and hence setting time will be increased significantly even at low dosage (0.2% wt.). If the initial setting time is very low the paste is drying fast then the workability of the paste is poor. Therefore, low initial setting time is not desirable. When the final setting time is too high again the drying time of the applied coat will be high. Then recoating will be delayed. Therefore, too high a final setting also not desirable.

4.4.2 Sample set 02

When RDP powder is added, again setting times have been gradually increased further from SAM 04 to SAM 08. Because polymer particles will cover the part of the surface area of the cement particles to reduce contact with water [27] and it will reduce the rate of hydration. Therefore setting time was increased with RDP addition from SAM 04 to SAM 08. Since the percentage of the blending of polymer is less, the surface area of cement particles covering is less. So, there is no significant setting times increment with RDP powder addition. Incorporation of MHEC and RDP powder shows a significant impact to increase the time required to change from a fluid state to a solid-state. According to the setting-times data, RDP addition % from 1.5 % to 2 % shows optimum results.

4.4.3 Sample set 03

When compare setting times results with optimum samples, all three market products show lower setting time results. Therefore, developed samples by the addition of RDP show improved properties than market products.

4.5 Test results-Flow properties of fresh skim coat paste

Flow table test results of fresh skim coat paste prepared with all formulations and market samples were given in Table.4.5 and Figure 4.5

Table.4.5 Flow properties of fresh skim coat paste

Sample No.	Flow (mm)
SAM 01	198
SAM 02	191
SAM 03	174
SAM 04	172
SAM 05	170
SAM 06	169
SAM 07	169
SAM 08	170
CON 01	183
CON 02	180
CON 03	187

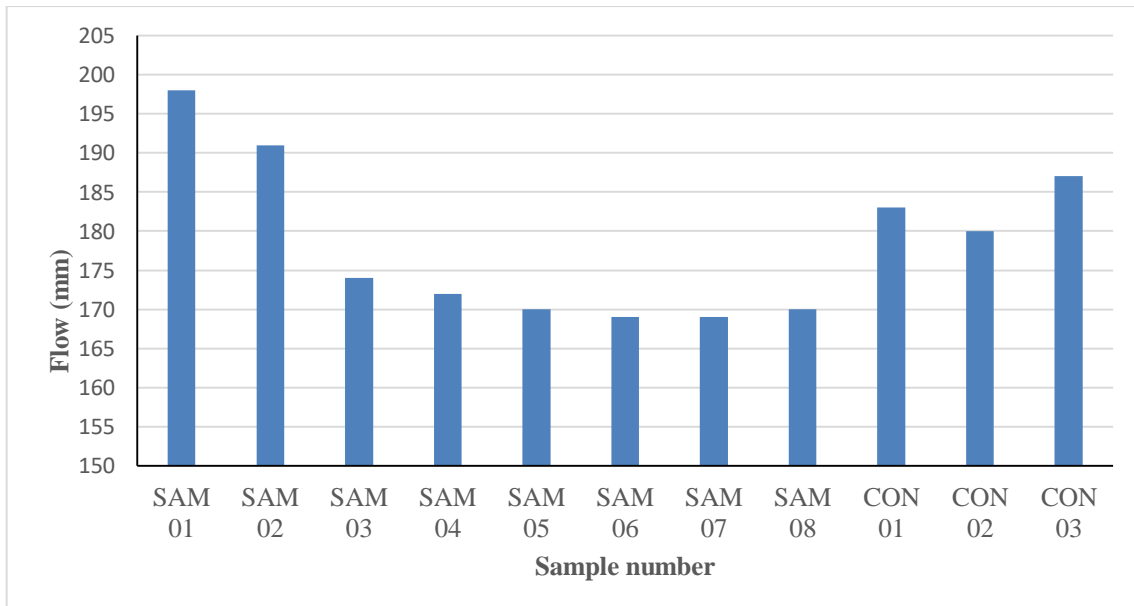

Figure 4.5: Flow properties of fresh skim coat paste

Flow properties of fresh paste depend on the water participating in the dispersing of cement particles [3]. Also, it is an indication of the viscosities of the prepared skim coat pastes. If the flow is less, viscosity is high. High and too low flow properties of the paste are not desirable in the practical situation of the decorative industry.

4.5.1 Sample set 01

Since there is no disturbing agent to the added water in SAM 01 has the highest flow property. Due to free water is high and dispersing of cement particles is high. When MHEC added flow properties significantly improved even at lower addition rate (0.2 % wt.). When introduced MHEC, a portion of free water migrates into the MHEC particles and it reduces free water content and reduced the flow. Since MHEC has high water absorption properties, with MHEC dosage there is significantly decreased flow behavior from SAM 01 to SAM 03.

4.5.2 Sample set 02

With introducing RDP powder, the flow has gradually decreased further up to SAM 06. When RDP blending some amount of water molecules creates cohesive forces with polymer particles and those water will not be the part of the dispersing of cement particles. So, flow properties will be reduced with polymer addition. But these cohesive forces are not significant, SAM 04 to SAM 07 has no big reduction of flow property compared to SAM 01. According to the results, the flow has optimum in SAM 06. Since air-entrained increased at the addition of an excess amount of RDP and these air bubbles create a lubricating effect between particles, so SAM 08 has a slight increment of the flow properties.

4.5.3 Sample set 03

According to the test results, market samples show comparatively high flow behavior than the optimum sample. This is not desirable and by introducing RDP, we can achieve improved flow properties than market samples.

4.6 Flexural and compressive strength of the hardened skim coat

Table 4.6 and figure 4.6 graphically shows test results of all sample formulations and market product's flexural and compressive strength of hardened skim coat;

Table 4.6: Flexural and compressive strength of the hardened skim coat

Sample No.	Flexural Strength (N/mm ²)	Compressive Strength (N/ mm ²)
SAM 01	2.9	11.5
SAM 02	2.9	9.5
SAM 03	2.8	9
SAM 04	3	9.5
SAM 05	3.2	10.5
SAM 06	3.6	10.4
SAM 07	3.9	10.3
SAM 08	4	10.2
CON 01	2.85	9.2
CON 02	2.9	9.8
CON 03	2.95	10.2

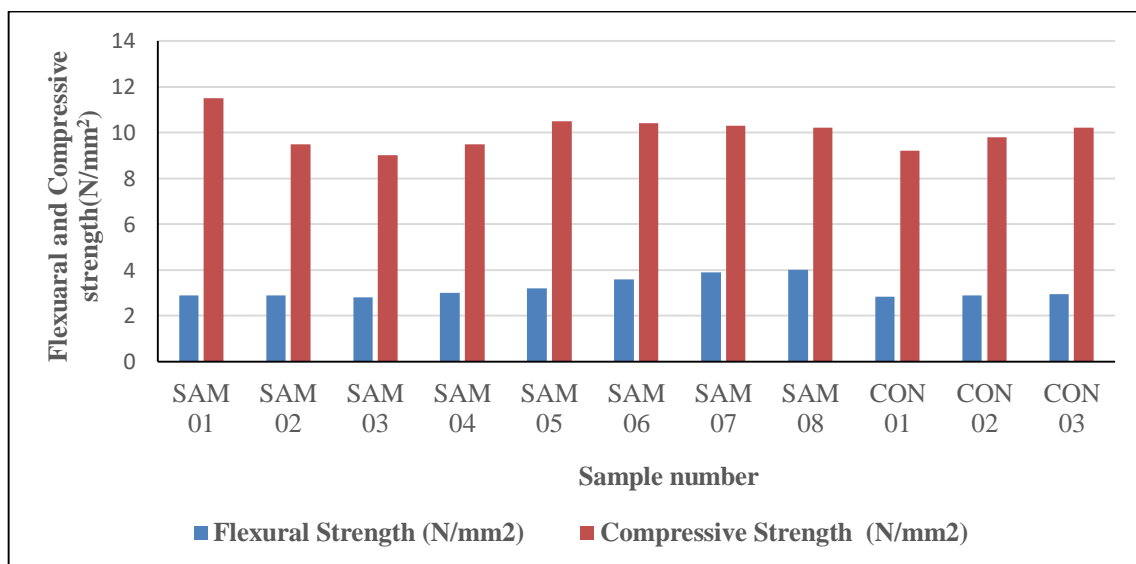

Figure 4.6: Flexural and compressive strength of the hardened skim coat

Flexural strength is a mechanical property of brittle materials and described as the ability to resist or withstand deformation due load. Modulus of rupture, fracture strength, and bend strength are also the same terms for the flexural strength. The most common test for the determination of flexural strength is the transverse bending test. In this test, three-point load bending was carried out for the test specimens with a rectangle or circular cross-section until yielding or fracture. At the moment of rupture of materials will experience the maximum stress and which is called as flexural strength. Until completion of the cement hydration, flexural strength is increasing accordingly. A material's or structure's capacity to withstand the loads tending to reduce the size, as opposed to tensile strength which withstands the loads tending to elongate is called compressive strength or compression strength. Compressive strength is a key value for the design of structures.

The compressive strength of dried cement mortar or skim coat paste depends on the compactness or bulk density/porosity of the dried skim coat paste or cement mortar.

4.6.1 Sample set 01

When MHEC blending it reduces the rate of hydration. But, it measured the flexural strength after 28 days it can be assumed that hydration has been completed. So, there are no significant differences in SAM 01 to SAM 03 even the addition of MHEC.

When MHEC added bulk density is reduced by entrained air creating porous structure inside the dried paste. So, compressive strength than decreased SAM 01>SAM 02>SAM 03 order.

4.6.2 Sample set 02

When RDP added the crack propagation is disturbed by polymer particles by creating bonds between cement particles. So, flexural strength is increased when increasing in the polymer dosage from SAM 04 to SAM 08.

When RDP added compactness of the dried mortar is increased up to SAM 05 and compressive strength is increased. Since the blending of higher RDP dosage bulk density of dried paste is decreased due to entrained air. So, there is a slight decrease in compressive strength in SAM 06 to SAM 08.

4.6.3 Sample set 03

When compare both strength results with RDP blended samples, market products show lower flexural and compressive strength values with RDP dosage above 1 % wt.

4.7 Adhesive Strength of Hardened skim coat layer

Table 4.7 indicates the test results of the adhesive strength of the hardened skim coat of all samples.

Table 4.7: Adhesive Strength of Hardened of the dry skim coat layer

Sample No.	Adhesion Strength (N/mm ²)
SAM 01	0.1
SAM 02	0.4
SAM 03	0.75
SAM 04	0.8
SAM 05	0.9
SAM 06	0.95
SAM 07	1.1
SAM 08	1.15
CON 01	0.6
CON 02	0.55
CON 03	0.45

Figure 4.7 shows variations of adhesive strength of hardened skim coat paste.

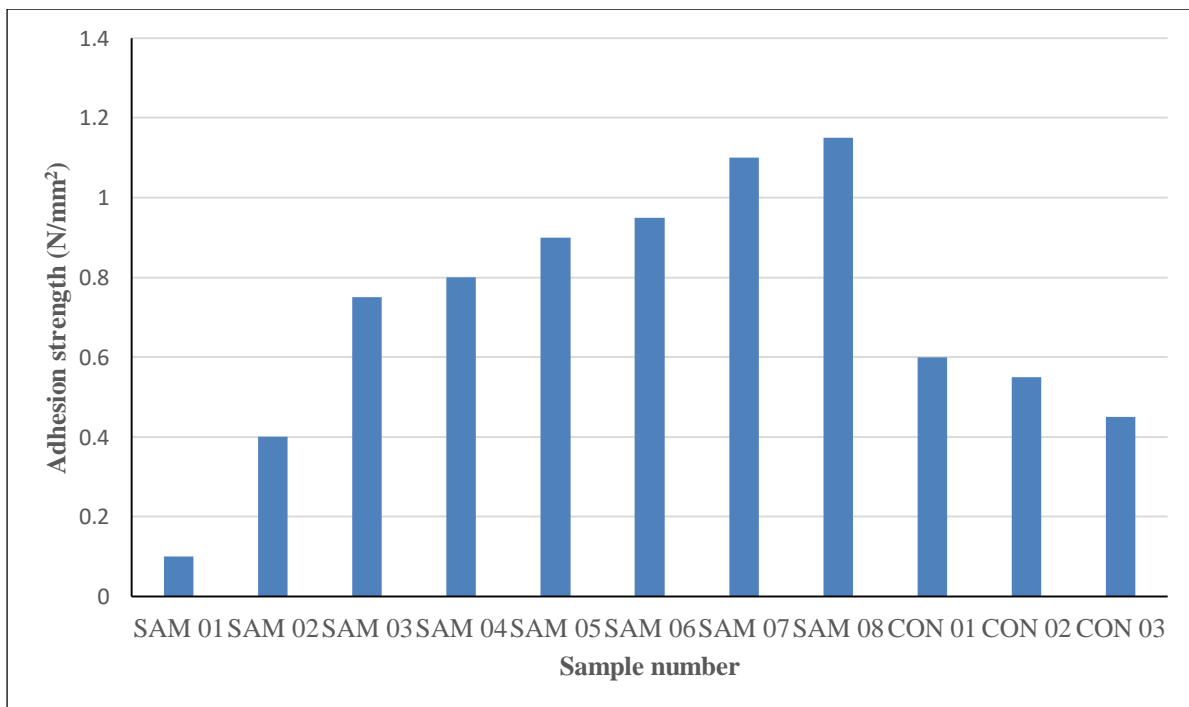

Figure 4.7: Adhesive Strength of dried skim coat

4.7.1 Sample set 01

According to figure 4.7, there is a significant adhesive strength increment when MHEC added. This variation is because of the perfect matrix structure formation due to the slow rate of cement hydration creates by MHEC. Also, adhesion strength has increased significantly even at 0.2 % wt. dosage. Therefore, we can observe a clear correlation between adhesion strength and MHEC dosage.

4.7.2 Sample set 02

When RDP added adhesive strength is gradually increased from SAM 03 to SAM 08. This is due to anchors creating between polymer particles and surface or substrate of dried paste.

4.7.3 Sample set 03

The adhesion strength of all samples contained RDP shows superior strength than market products even at 0.5 % wt. dosage.

4.8 Capillary Water Absorption of Hardened skim coat paste

Table 4.8 shows the time required to reach the equilibrium of water absorption and the amount of maximum water absorption at the equilibrium point.

Table 4.8: Capillary Water Absorption of hardened skim coat paste

Sample No	Capillary water absorption (kg/m ²)												
	10 min	10 min	30 min	90 min	120 min	240 min	360 min	480 min	600 min	720 min	900 min	1200 min	1440 min
SAM01	0	2	3.6	5.5	6.3	8	9.25	9.5	9.9	10	10	10	10
SAM02	0	1.2	2.6	4	4.8	5.6	6.25	6.5	6.75	6.9	7	7	7
SAM03	0	1	1.8	3.5	3.8	4.2	4.5	4.75	4.9	5	5	5	5
SAM04	0	0.9	1.6	3.1	3.4	3.9	4.2	4.3	4.4	4.5	4.5	4.5	4.5
SAM05	0	0.7	1.4	2.8	3	3.4	3.6	3.7	3.8	3.9	3.9	3.9	3.9
SAM06	0	0.55	1.2	2.5	2.7	3	3.1	3.3	3.4	3.5	3.5	3.5	3.5
SAM07	0	0.62	1.27	2.65	2.9	3.1	3.3	3.4	3.5	3.7	3.7	3.7	3.7
SAM08	0	0.66	1.3	2.7	3.2	3.4	3.5	3.6	3.7	3.8	3.8	3.8	3.8
CON01	0	1.1	2.1	3.7	4.1	4.5	4.9	5.4	5.7	6	6	6	6
CON02	0	1.4	2.3	3.8	4.3	4.8	5.2	5.7	5.9	6.3	6.3	6.3	6.3
CON03	0	1.6	2.4	3.9	4.5	5.1	5.7	6.2	6.5	6.7	6.7	6.7	6.7

Figure 4.8 shows the maximum amount of water absorption by each of dried hardened skim coat cubes.

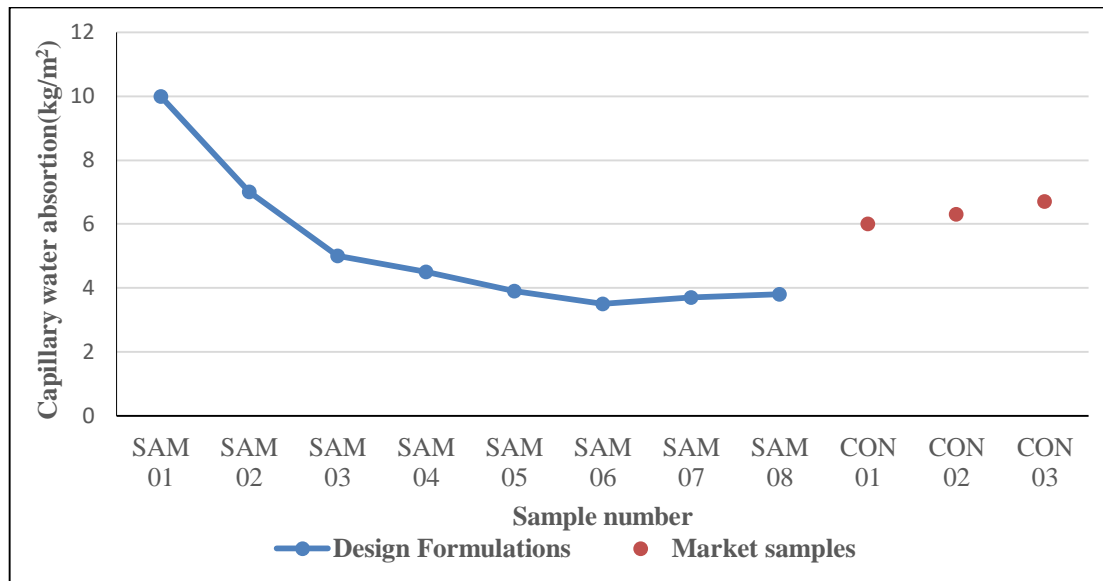

Figure 4.8 Capillary Water Absorption after 900 minutes

The water absorption depends on the micro-cracks or interconnecting holes, porosity and pore size distribution of the dried skim coat paste [28]. If the rate of cement hydration is high, surface cracks and micro-cracks formation will be high due to irregular matrix formation. When reduced the capillary water absorption, it will help to reduce or block the water migration through the skim coat layer. So, we can minimize the bad effect of efflorescence. Again, lower the water absorption, reduced the primer absorption also, then the cost of paint will be reduced further.

4.8.1 Sample set 01

Since the rate of cement hydration was high in SAM 01, so, micro-cracks formation is high in SAM 01 and it had the highest capillary water absorption even under the high compact structure. When MHEC added, it will lower the free water within the fresh paste. Therefore it will reduce the rate of hydration. So, surface cracks formation is less [28]. Therefore sample SAM 02 and SAM 03 having less capillary water absorption than SAM 01 even under porous structure in the dried paste. From SAM 01 to SAM 03, there is a 50% capillary water absorption reduction. Therefore, we can observe a proportionate reduction of capillary water absorption with increasing MHEC % wt.

4.8.2 Sample set 02

When introducing RDP, further reduction of capillary water absorption observed from SAM 04 to SAM 06 and it has the lowest capillary water absorption (3.5 kg/m^2) in SAM 06, further increasing of RDP excess of 1.5 %wt. again water absorption tends to increase. When introducing RDP reduce the hydrophilic and RDP film fills the pores within a cement matrix structure. Therefore, capillary water absorption getting decreased. At high RDP dosage, reduce flow properties of cement/skim coat paste and due to uneven dispersion of cement/skim coat paste interconnecting holes and pores may increase. Therefore, we can observe a significant impact of RDP on reducing the capillary water absorption, which was 30% lower than SAM 03.

4.8.3 Sample set 03

When comparing optimum formulation/SAM 06, capillary water absorption of market products was significantly high. The sample CON 03 has a 60% higher capillary water absorption value than SAM 06.

4.9 Surface water absorption of the dry skim coat layer

Table 4.9 shows surface water absorption by 2 mm thick dried skim coat layer,

Table 4.9: Surface water absorption of the dry skim coat layer

Sample Number	Water Absorption (kg/m^2)
SAM 01	2.039
SAM 02	1.632
SAM 03	1.453
SAM 04	1.231
SAM 05	0.994
SAM 06	0.849
SAM 07	0.853
SAM 08	0.869
CON 01	1.512
CON 02	1.598
CON 03	1.623

Figure 4.9 graphically shows the variation of surface water absorption by hardened skim coat layer,

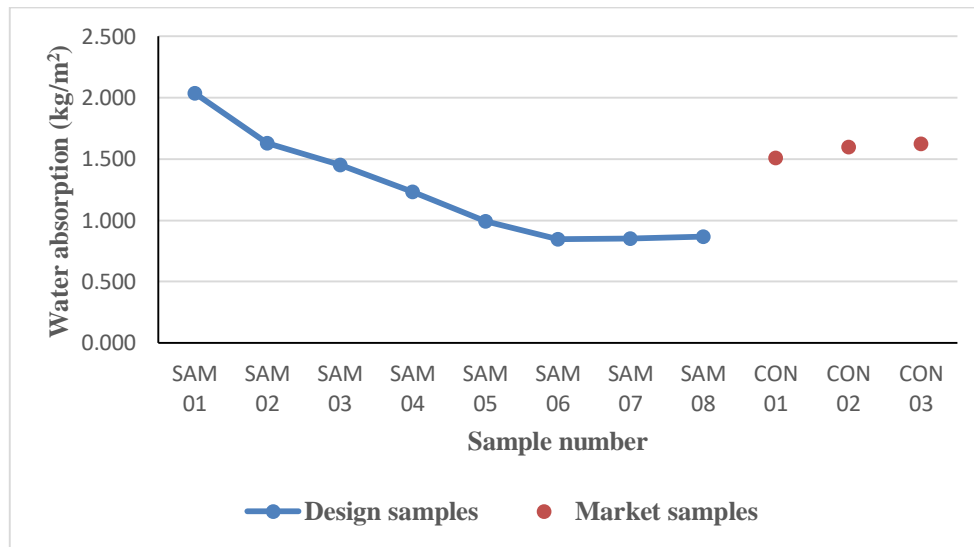

Figure 4.9: Surface Water Absorption of hardened skim coat paste

Surface water absorption depends on the degree of surface cracks, surface porosity, and surface irregularity. If the surface is more irregular, large surface area, more surface cracks present. Then water absorption will be increased. If the surface is smooth, low surface area, fewer surface cracks, and low porosity and hence the low water absorption observed.

4.9.1 Sample set 01

SAM 01 has a higher degree of surface cracks due to the higher rate of cement hydration. When introducing MHEC surface cracks are lesser than the SAM 01 due to the low rate of cement hydration forming smooth surfaces by SAM 02 (1.632 kg/m²) and SAM 03 and have less surface water absorption than the SAM 01 (2.039 kg/m²), which is 20% lower than SAM 01.

4.9.2 Sample set 02

When RDP introducing the rate of cement hydration reduce from SAM 03 to SAM 06 and gradually decreased surface water absorption is justified. But, when it increased the percentage of polymer further, the positive effect of the cement hydration was canceled due to agglomerate of the polymer creating poor mixing properties. So, SAM 07 and SAM 08 have the almost same surface water absorption rates as SAM 06, which has the lowest surface water absorption (0.849 kg/m²). When comparing with SAM 03, which contained no RDP, SAM 06 has 42 % lesser surface water absorption. Therefore, we can minimize the effect of the aesthetic finish of the surfaces and internal metal structures damaged by efflorescence.

4.9.3 Sample set 03

Since the optimum sample is SAM 06 which has the lowest surface water absorption, all market products are having a higher percentage of the same properties. Example: Sample SAM 06 has 48 % lower surface water absorption than CON 03.

4.10 Pencil Hardness test results

Table.4.10 shows test results of surface hardness of hardened skim coat layers using a pencil hardness kit.

Table.4.10 Surface hardness of hardened skim coat layer

Sample Number	Pencil Hardness	Hardness unit
SAM 01	8B	2
SAM 02	7B	3
SAM 03	HB	10
SAM 04	F	11
SAM 05	H	12
SAM 06	2H	13
SAM 07	3H	14
SAM 08	3H	14
CON 01	5B	5
CON 02	6B	4
CON 03	7B	3

Table.4.10 and Figure 4.10 graphically show the variation of the hardness of dried skim coat surfaces including market samples.

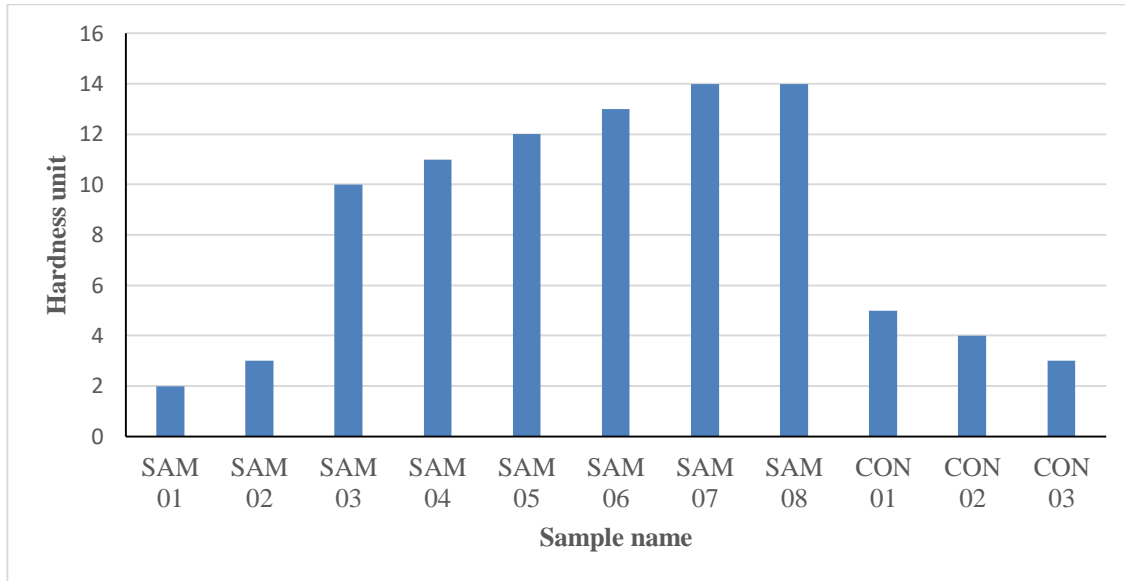

Figure 4.10: Surface hardness of hardened skim coat layer

Pencil hardness measures the scratch resistance of the surface [29]. If the surface hardness is too high it is difficult to level the applied skim coat layer by sanding with sandpaper. Also, when the surface is too soft it is not desirable and the surface will damage even with low impact force and chalking will be resulted. Therefore products having medium surface hardness ideal for the decorative industry. If the surface is firm and consists of a strong network or interconnection, it shows high scratch resistance or pencil hardness.

4.10.1 Sample set 01

The addition of the MHEC has improved the scratch resistance. A significant improvement can be observed from SAM 2 to SAM 03. It indicates the impact of the relative amount of MHEC to the scratch resistance. When introducing MHEC, the rate of cement hydration less, which helps to build perfect network structure and interconnection between cement particles. In SAM 01 contained no MHEC, so the skim coat paste is dried rapidly by evaporating and absorbed by the substrate, so cement hydration will not uniform. Then the soft surface will result.

4.10.2 Sample set 02

The results show the impact of the addition of polymeric materials and the relative amount to the scratch resistance of the dried surface of the skim coat layer. Gradual improvement can be observed from SAM 04 to SAM 07. It indicates the impact of RDP powder to improve scratch resistance. So, from SAM 04 to SAM 07 has firm and consists of a strong network or interconnection in the surface layer, which shows high scratch resistance or pencil hardness.

4.10.3 Sample set 03

Scratch resistance of the dried skim coat layer of the SAM 06 has significantly higher hardness value than the market products. Surface hardness is desirable in SAM 06.

4.11 Cost Analysis

To compare the cost and performance, a developed product (Optimum sample/SAM 06) and market products were considered,

For the costing, bulk unit raw materials prices were obtained from the market,

Dolomite powder-Rs.8.00/kg,MHEC-Rs.950/kg,White cement-Rs.26/kg,RDP-Rs.445/kg and packing cost (paper bag)-Rs.35/bag.

According to the calculation, raw material price of 20 kg of SAM 06 product with packing was Rs.683/= with allocating 50 % of margin for other overheads, transport, marketing and profit from the raw materials and packing cost (Rs.455/=). According to the Table 2.1 retail prices of 20 kg market products (COA 01, CON 02 and CON 03) were Rs,650/=, Rs.650/=, and Rs.620/= respectively.

Assumptions:

- The spreading capacity of SAM 06 and market products was considered as same and 100 sqft/20 kg bag.
- Cost of a market waterproofing paint,approx.Rs.20/sqft.

The material cost of developed product according to the SAM 06 and market products was given below in table 4.11;

Table 4.11: Raw material cost for one square foot (sq.ft) of Skim coat product

Sample Name	Cost per sq.ft (Rs/sq.ft)
SAM 06	6.83
CON 01	6.50
CON 02	6.50
CON 03	6,20

According to table 4.11, SAM 06 has a higher cost by Rs.0.33/sq.ft than market products (CON 01 and CON 02), also higher the cost by Rs.0.63/sq.ft than CON 03. It is approximately increased cost by 5 % and 10 % respectively.

But comparing, application and mechanical properties enhancement of the relevant product (SAM 06), these increment has a low impact on the cost. Therefore, using the skim coat product with SAM 06 formulation has an added advantage over the tested market products. Hence, it will reduce the cost of waterproofing as well.

CHAPTER 5:

CONCLUSIONS AND RECOMMENDATIONS

5.1 Conclusions

This study investigated the development of application and final performance of the cement-based skim coat putty after blending various amounts of selected RDP powder while maintaining other key properties of the product at the optimum level. Mainly capillary water absorption and surface water absorption measured using dried/cured skim coat paste. According to the test results in this study, the main findings are given below:

- RDP powder affects reducing capillary and surface water absorption. However, the relative amount of RDP powder reaches to 1.5 wt. % the dried or cured layer of skim coat reached maximum waterproofing level. The incorporation of excess RDP powder caused to increase the water absorption in both ways due to agglomerate of the polymer particles in the paste increasing air-entrained and resulting porous structure.
- With the addition of RDP powder, mechanical properties show a significant increase at the beginning and with a high dosage, start to decrease. Flexural strength has increased with the RDP powder while compressive strength has optimum with addition level around 1 wt. % to 1.5 wt. %. Also, adhesive strength has increased with the addition of RDP powder.
- Other key properties of fresh paste have influenced positively with the addition of RDP powder up to a certain level. Flow property of the fresh paste has optimum in SAM 06 and decrease after dosage at 1.5 wt. %. The open time also improved with a percentage of RDP powder.
- With considering all the details, the addition of 1.5 wt. % RDP powder to the formulation has an optimum effect on the fresh & dried skim coat paste.

5.2 Recommendations

In this study used only un-modified RDP powder and reduced capillary water absorption by 30 % and surface water absorption by 42 % only. Therefore, it couldn't overcome the effect of efflorescence significantly. So, in future research by blending various hydrophobic additives and modified special polymer products will further improve the above properties, using those will be able to overcome the effect of efflorescence significantly.

BIBLIOGRAPHY

- [1] Fergus Rupert Fitzgerald, “ COATING SYSTEM COMPRISING A DRY POWDER COMPOSITION DISPERSIBLE IN WATER”. USA Patent US 7,205,031 B2, 17 04 2007.
- [2] Eva Paz, Julian Narbon, Juana Abenojar, M.M.Cledera-Castro, Juan Del Real, “Influence of Acrylic Adhesive viscosity and Surface Roughness on the properties of Adhesive joint,” *The Journal of adhesion*, vol. 11, p. 92, 4 2015 July.
- [3] D. D. Nguyen • L. P. Devlin • P. Koshy • C. C. Sorrell, “Impact of water-soluble cellulose ethers on polymer-modified mortars,” *Journal of Materials Science*, pp. 923-928, 2013.
- [4] J. M. L. VILAS BOAS, S. L. MACHADO, S. A. PINTO, “Filter paper method to determine the water retention curves for mortar and cement samples,” *SCIELO*, July/August 2016.
- [5] A. T. R. & B. E. Lang J., “Skim coats-How Organic Additives improve the Quality,” in *3 rd Indian Drymix Mortar Conference*, Mumbai, 2014.
- [6] A. D. C. Marco Cappellari, “Influence of organic thickening admixtures on the rheological properties of mortars: Relationship with water-retention,” *ScienceDirect*, vol. 38, pp. 950-961, 2013.
- [7] Teresa M.Pque, Stefan Bauergger, Johann Plank, “Influence of temperature and moisture on the shelf-life of cement admixed with re-dispersible polymer powder,” *Construction and Building Materials*, vol. 115, pp. 336-344, 2016.
- [8] S.P.Zhang, L.Zong, “Evaluation of Relationship between Water Absorption and Durability of Concrete Materials,” *Advances in Materials Science and Engineering*, vol. 2014, p. 8, Apri,2014.
- [9] O. Ruskulis, *Hydraulic Lime: An Introduction*, United Kingdom: Practical Action, United Kingdom, 2014.

- [10] Nataliya Lushnikova, Leonid Dvorkin, Sustainability of gypsum products as a construction material, Woodhead Publishing, August 2016.
- [11] H. c. g. Indocement, “Manufacture Test Certificate,” Indocement group, West Java-Indonesia, 2018.
- [12] M.W.Bligh, M.N.d'Eurydice, R.R.Llyod, C.H.Arns, T.D.Waite, “Investigation of early hydration dynamics and microstructural development in OPC using H NMR relaxometry and isothermal calorimetry,” *Cement and Concrete Research*, vol. 83, pp. 131-139, 2016.
- [13] Pauline L. Nasatto 1,2,* , Frédéric Pignon 2,3, Joana L. M. Silveira 1, “Methylcellulose, a Cellulose Derivative with Original Physical Properties and Extended Applications,” *Polymers*, vol. 7, pp. 777-803, 2015.
- [14] J.Pourchez,A.Peschard,B.Guilhot,P.Grosseau,R.Guyonnet,B.Guilhot,F.Vallee, “HPMC and HEMC influence of cement hydration,” *Cement and Conctete research*, vol. 36, pp. 288-294, 2006.
- [15] Jean-Yves Petit,Eric Wirquin, “Evaluation of various cellulose ethers performance in ceramic tile adhesive mortars,” *International Journal of Adhesion and Adhesive*, vol. 40, pp. 202-209, 2013.
- [16] D. D. Nguyen • L. P. Devlin • P. Koshy • C. C. Sorrell, “Impact of water-soluble cellulose ethers on polymer-modified mortars,” *Materials Science*, pp. 924-951, September 2013.
- [17] R. Horbart M.king (Ph.D, “Dolomite(mineral),” *GeologyScience News and information*, 2005.
- [18] D. Zubriggen, “Influence of redispersible powder on Shrinkage,hydration behaviours and microstructure of tile adhesive,” Elotex AG,Industriestr, Sempach Station, 1998.
- [19] Joachim Schulze, Otmar Killermann, “Long-term performance of redispersible powders in mortars,” *Cement and Concrete Research* , vol. 31, pp. 357-361, 2001.

- [20] ASTM International, *ASTM C191-19, Standard Test Methods for Time of Setting of Hydraulic Cement by Vicat Needle*, West Conshohocken, PA: ASTM International, , 2019.
- [21] Jie Fan, Gengying Li, Sijie Deng and Zhongkun Wang, “Mechanical Properties and Microstructure of Polyvinyl Alcohol (PVA) Modified Cement Mortar,” *Applied science*, vol. 2178, p. 9, 2019.
- [22] Ru Wang, Pei Wang, “Action of redispersible vinyl acetate and versatate copolymer powder in cement mortar,” *Construction and Building Materials*, vol. 25, pp. 4211-4214, 2011.
- [23] Carlos Eduardo M. Gomes, Osny P. Ferreira , “Analyses of Microstructural Properties of VA/VeoVA Copolymer Modified Cement Pastes,” *Ciência e Tecnologia*, vol. 15, pp. 193-198, 2005.
- [24] Marco Cappellari, Anne Daubresse, Mohend Chaouche, “Influence of Organic thickening admixture on the rheological properties of mortars: Relationship with water retention,” *Construction & Building Materials*, vol. 38, pp. 950-961, 2013.
- [25] J. Pourchez B. Ruot, J. Debayle, E. Pourchez, P. Grosseau , “Some aspects of cellulose ethers influence on water transport and porous structure of cement-based materials,” *Cement and Concrete Research*, vol. 40, pp. 242-252, 2010.
- [26] A. J. Pourchez, “HPMC and HEMC influence on cement hydration,” *Cement and Concrete Research*, vol. 36, pp. 288-294, 2006.
- [27] D. D. J. F. Marcin Kulesza, “Effect of redispersible polymer powder on setting time of thin bed mortars,” in *MATEC Web of Conferences 163, 04005 (2018)*, 2018.
- [28] Mateuz Wyrzykowski, Rene Kieswetter, Beat Munch, Robert Baumann, Pietro Lura, “Pore structure of mortar with cellulose ether addition-Study of the air-void structure,” *Cement & Concrete Composite*, vol. 62, pp. 117-124, 2015.
- [29] Ramachandra S.R. Kalidindi, Raghavan Subasri, “Sol-gel nanocomposite hard coatings,” in *Anti-Abrasive Nanocoatings*, WOODHEAD PUBLISHING, 2015, pp. 105-136.

- [30] J. Szymanowski, “Evaluation of the Adhesion between Overlays and Substrates in Concrete Floors: Literature Survey, Recent Non-Destructive and Semi-Destructive Testing Methods, and Research Gaps,” *Buildings*, vol. 9, p. 23, September 2019.